

**1** PIECES

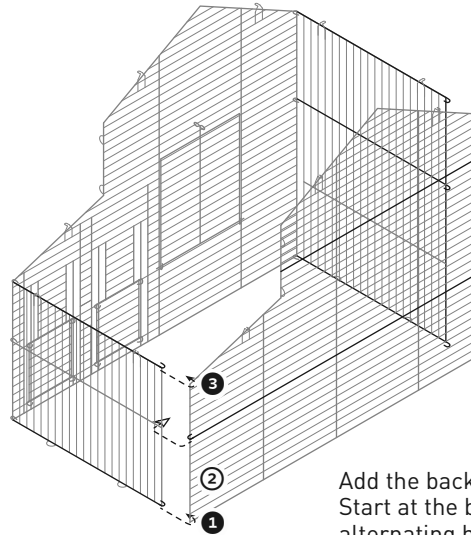

Add the back panel to the 3-panel mesh. Start at the bottom and weave the alternating hooks together up the seam. Done correctly, the short-side seam will look like this →

Weave the panels together on the remaining seam by the same method.

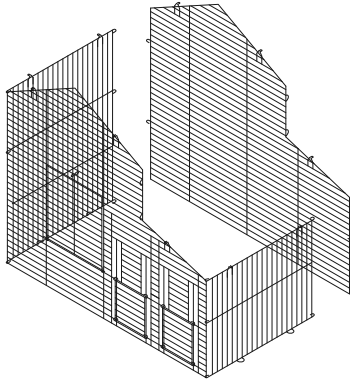
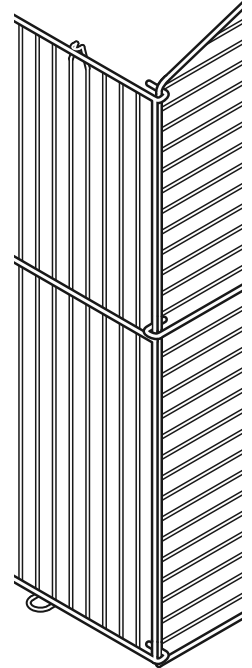

**2** PIECES

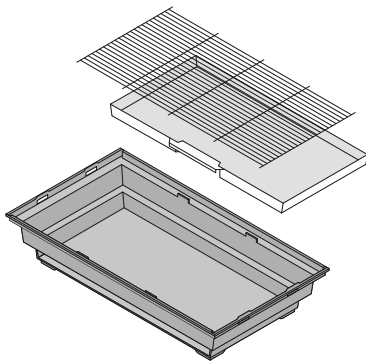

Place the removable grille into the base.

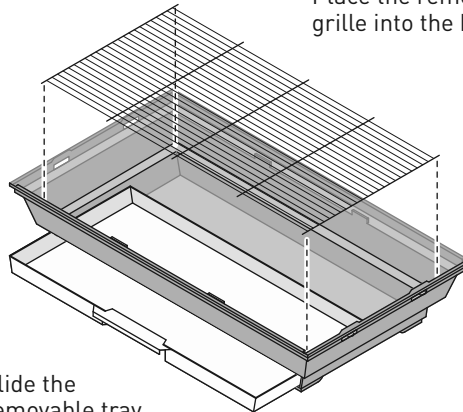

Slide the removable tray into the opening.

Add the assembled mesh to the base by inserting the extended loops along the sides into the open slots on the base.

Along the front and back edges, set the mesh between the raised tabs and the rim.

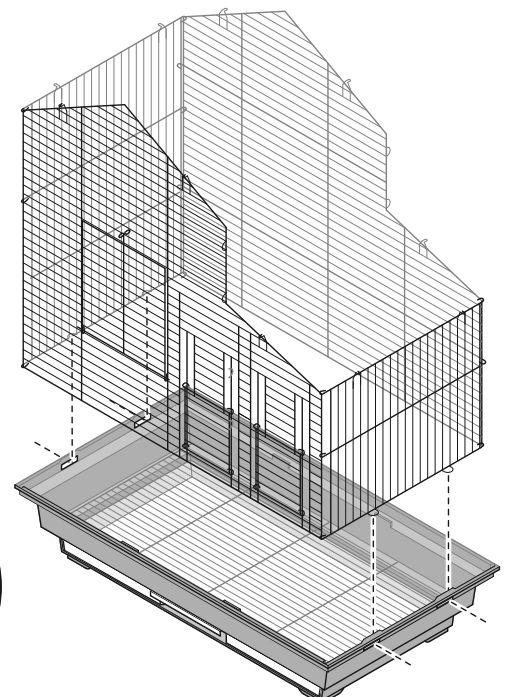
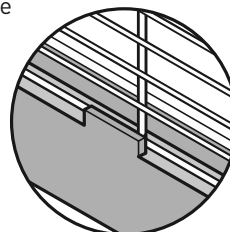

# 3 PIECES

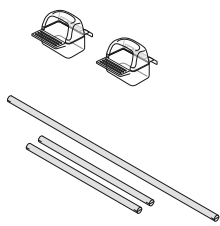

Install perches on horizontal wires at an equal height.

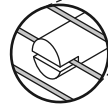

When installing a perch on a vertical wire, set the bottom to rest on a horizontal wire for stability.

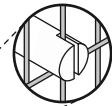

Assemble the two-piece cups, slide the cup doors up and insert the cups into place.



# 4 PIECES

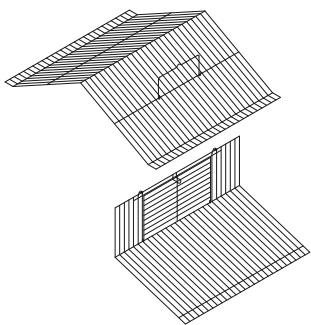

**1** Start with the side roof, along the bottom, side edge. Catch the inner horizontal roof wire on the hooks.

**2** Lean the roof back into place, and catch the vertical roof wires on the vertical side loops.

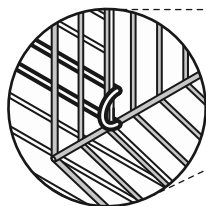

**2**

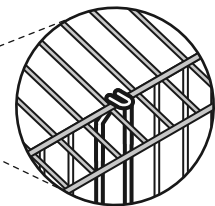

**1**

## \* CLEANING INSTRUCTIONS

To prolong the life of your new Prevue Pet Products cage, we recommend:

- When cleaning the cage and parts, use a soft cloth or non-abrasive scrub pad (such as Prevue's Cage Saver (#109)).
- Wash all parts with warm water and a mild, pet-safe, environmentally friendly soap.
- Rinse thoroughly.
- Hand dry all parts completely with a soft dry cotton cloth before reassembling the cage.
- Do not leave plastic parts in the sun to dry as they may warp.

Finish with the peaked roof panel. Start on one end, catch the roof on the looped hooks along the tall side panel, then along the front and back panels, and finish with catching the roof on the hooks along the short roof panel.

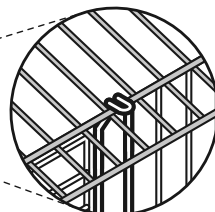
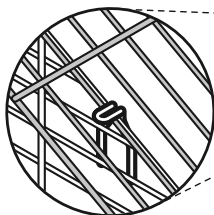

Assembly completed. 