

Follow this bunny trail

1

READ!

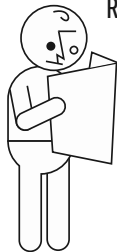

READ!

READ!

READ THESE INSTRUCTIONS!

If you've never followed instructions before, this is a good time to start! These tips have been compiled to lead you to a successful assembly. We know you can do this!

If you still run into trouble, you can call our Prevue Customer Service line at 1 (312) 243-3624.

2

LEVEL = GOOD!



NOT LEVEL = NOT GOOD

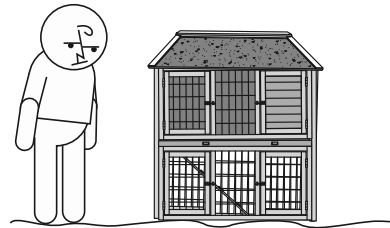

FIND A LEVEL SURFACE

Build your hutch on a flat surface and, with a friend, carry it to the location where it will be used. Assembling the hutch on the flattest surface available will help you greatly when squaring up panels and aligning the roof panels.

3

FRIEND ME!

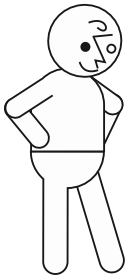

FIND A FRIEND (or GO IT ALONE—both are OK)

If you follow these steps, hutch assembly will be easy for one person. But you may find a second person's assistance useful in some steps.

If you have to move the assembled hutch to its final location, you will most certainly need assistance to protect the integrity of the structure.

4

EASY AS 1-2-3!

5... 6... 7... 8... 9... 10...



COUNT CONTENTS OF HARDWARE PACKETS

After unpacking all components, count the contents of the screw packets. Compare the counts against the Parts List on the next page. There should be at least one spare for each packet. If any packets are short, please contact Prevue or use your own appropriate-size replacements.



For successful assembly of your MODEL #4601 Duplex Rabbit Hutch

Follow this bunny trail

5



CARE ADVISORIES

For the comfort and health of your rabbit, this hutch size is most appropriate for 1 small to medium size rabbit or 2 dwarf rabbits.

•

When moving the hutch, remember the ramp is on a hinge and will dangle down below the base when the hutch is lifted off the ground.

CUSTOMER SUPPORT

Please contact Prevue Pet Products:

PHONE 1 (312) 243-3624

ONLINE www.prevuepet.com

EMAIL customerservice@prevuepet.com

These instructions are online, under the item's detail listing at www.prevuepet.com.

To maintain the longevity of your purchase, we recommend that you periodically treat it with a non-toxic sealant and protect it with a tarp or other covering during extended periods of inclement weather.

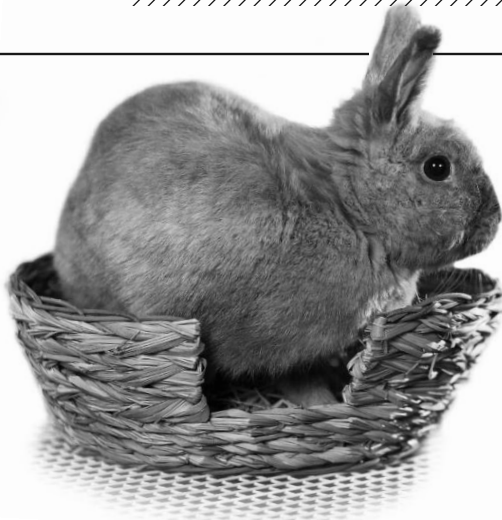

For more wonderful cages, toys, and accessories for dogs, cats, birds, chickens, rabbits, ferrets and small animals, visit www.prevuepet.com



MODEL #4601 Duplex Rabbit Hutch

PARTS LIST

CUSTOMER SUPPORT

Please contact Prevue Pet Products:

PHONE 1 (312) 243-3624

ONLINE www.prevuepet.com

EMAIL customerservice@prevuepet.com

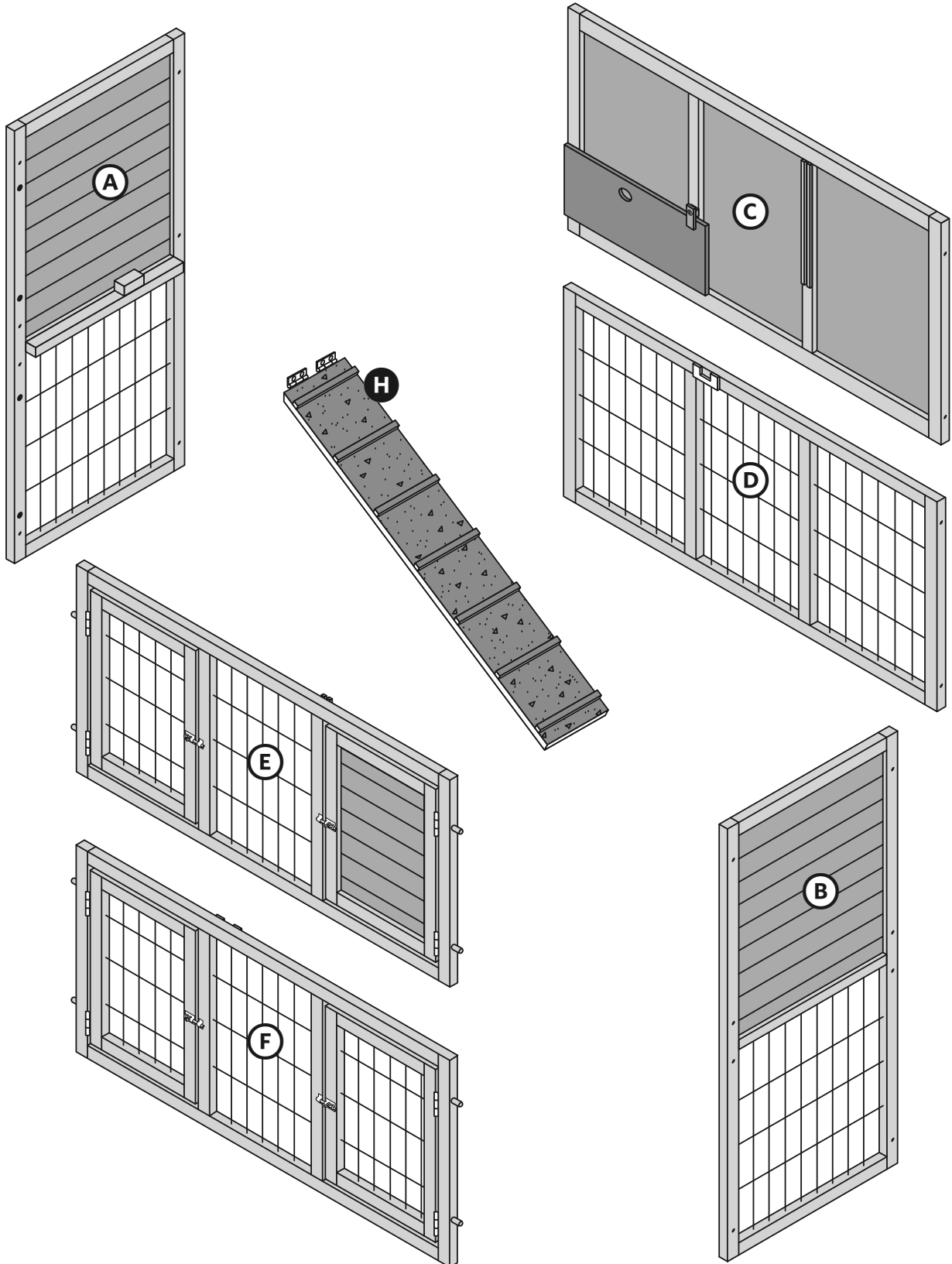



MODEL #4601 Duplex Rabbit Hutch

PARTS LIST

CUSTOMER SUPPORT

Please contact Prevue Pet Products:

PHONE 1 (312) 243-3624

ONLINE www.prevuepet.com

EMAIL customerservice@prevuepet.com

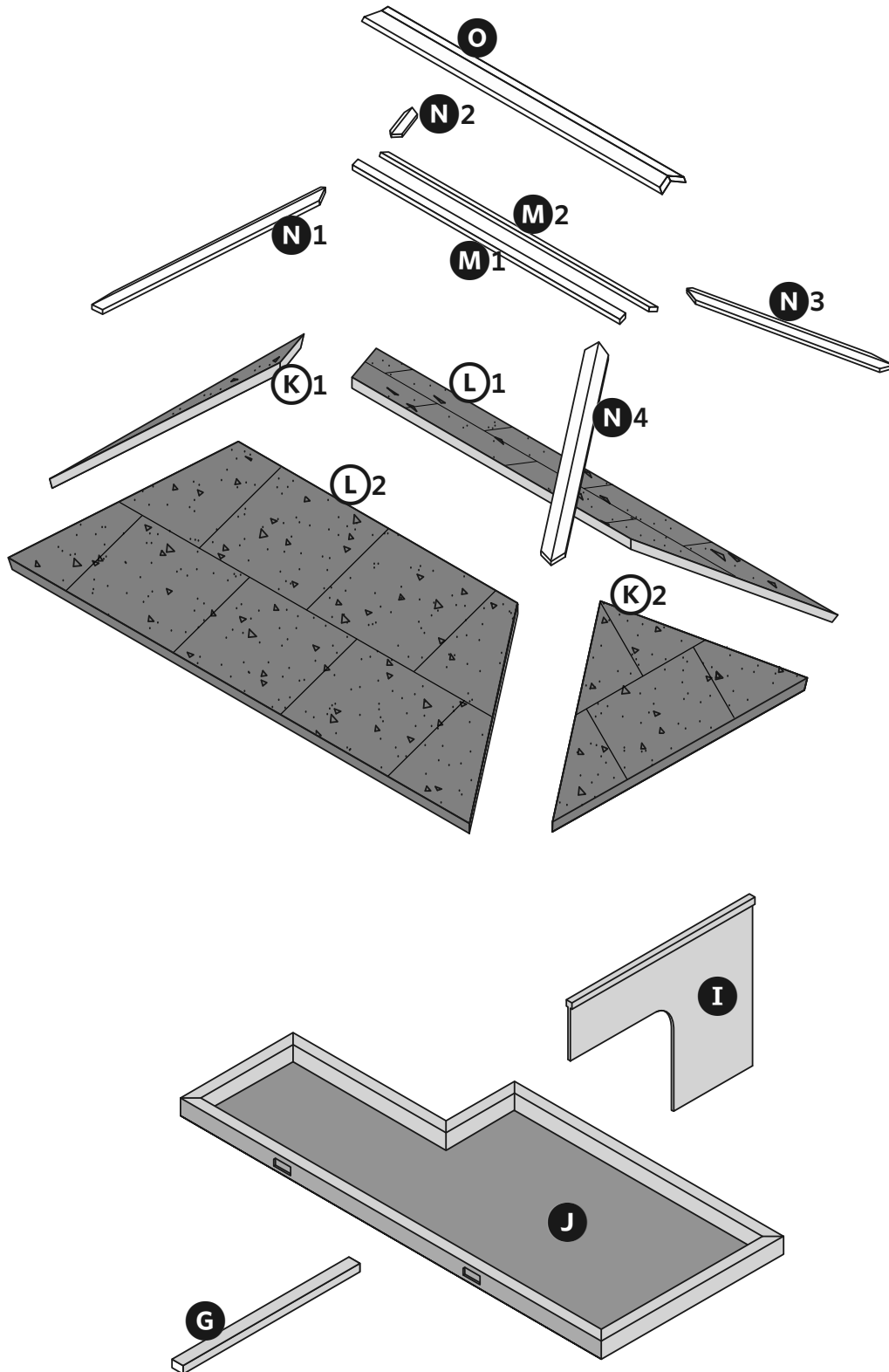

HARDWARE INCLUDED:

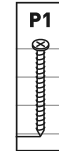

P1
1⁹/₁₆"L (40mm)
16 pcs +1
(use All in Step 1)

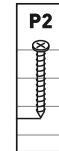

P2
1³/₈"L (35mm)
10 pcs +1
(use All in Step 3)

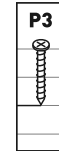

P3
1"L (25mm)
28 pcs +1
(use All in Step 3)

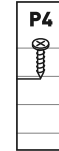

P4
5/₁₆"L (14mm)
4 pcs +1
(use All in Step 2)

TOOLS REQUIRED:



**Screwdriver
or power drill
with
Phillips head
end/bit**

Duplex Rabbit Hutch

Model: #4601 Instructions online at www.prevuepet.com

CUSTOMER SUPPORT

Please contact Prevue Pet Products:

PHONE 1 (312) 243-3624

ONLINE www.prevuepet.com

EMAIL customerservice@prevuepet.com

1 Assemble the HUTCH BODY. You will need these pieces:

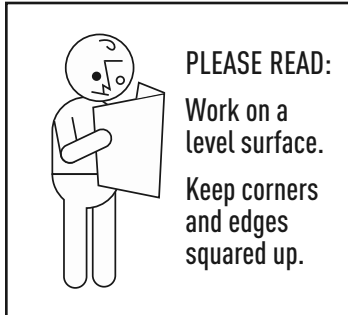
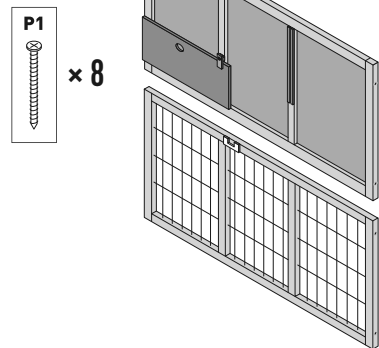
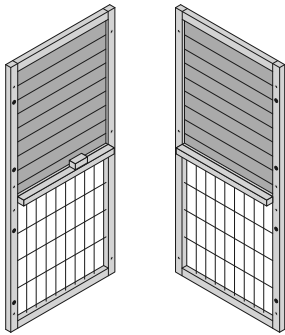

PLEASE READ:

Work on a level surface.

Keep corners and edges squared up.

Begin with the sides and the lower back panel.

Attach the side panels to the back panel with [P1] screws, using the pre-drilled starter holes as guides.

Next, attach the upper back panel in the same manner.

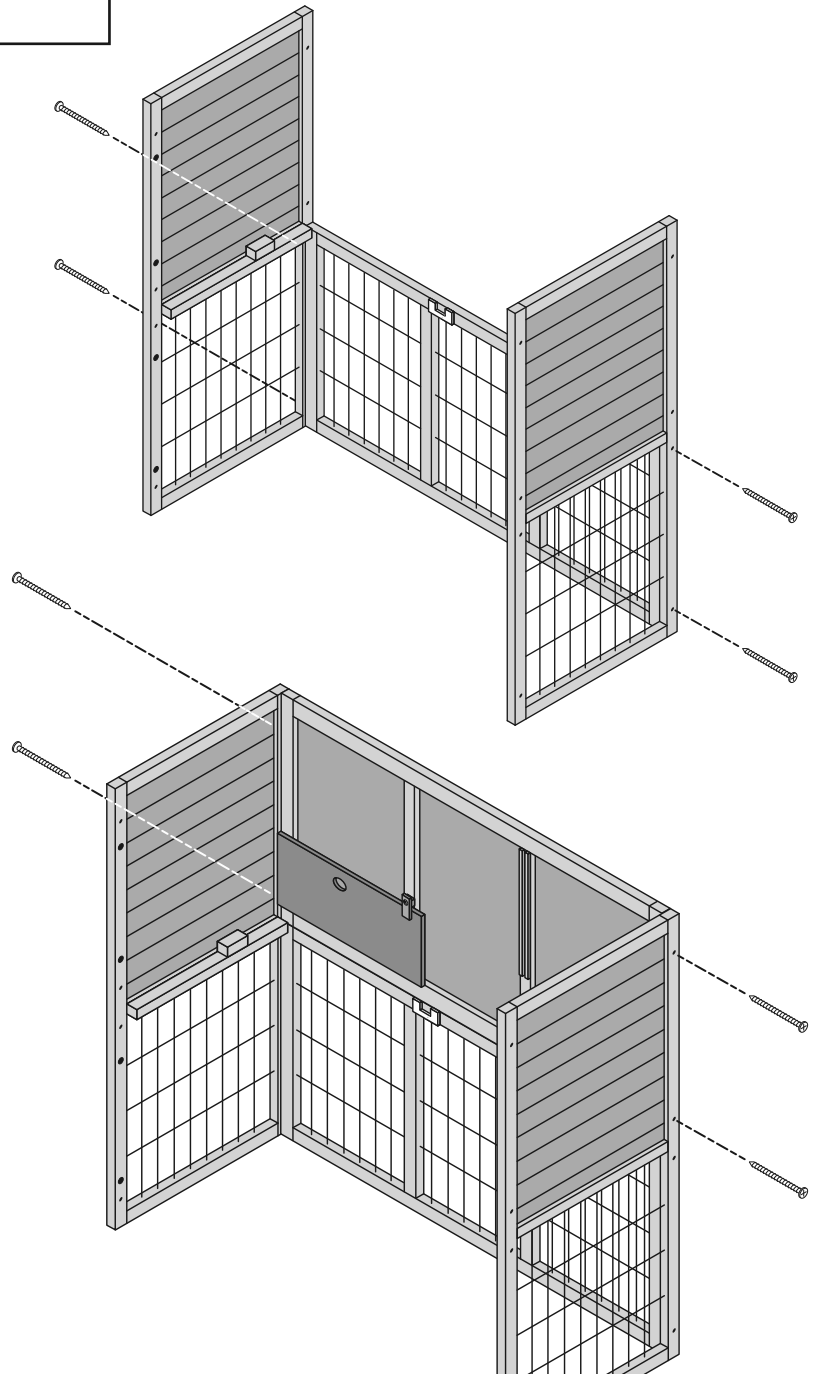

1 ...continued

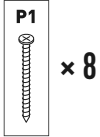
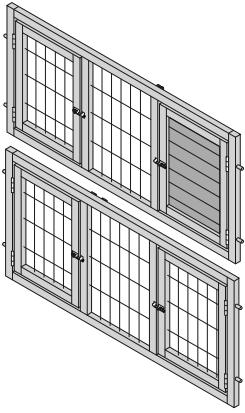

The front panels feature pre-installed wood dowels to help position the panels correctly for the hutch floor tray.

Align the dowels with the pre-drilled companion holes and insert, pressing the panels together.

From the frame exterior, attach the side panels to the front panels with [P1] screws, using the pre-drilled starter holes as guides.

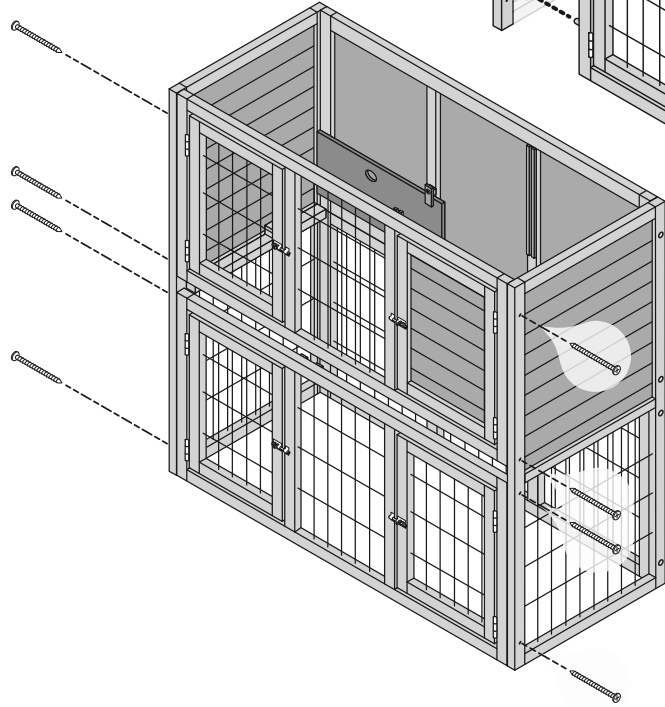
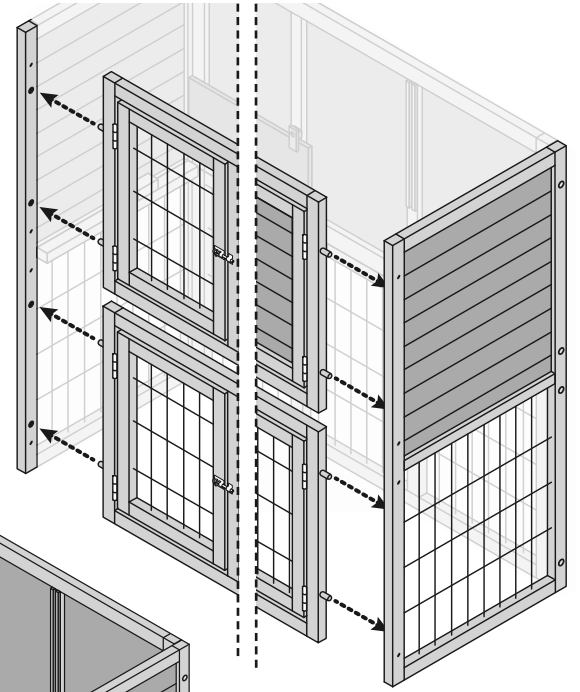

2 Assemble the HUTCH COMPONENTS. You will need these pieces:

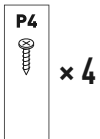
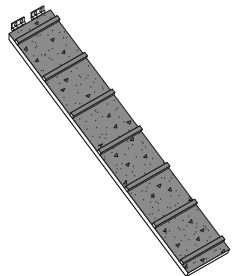

RUNWAY RAMP

Place the runway ramp in position and attach it to the side panel with [P4] screws.

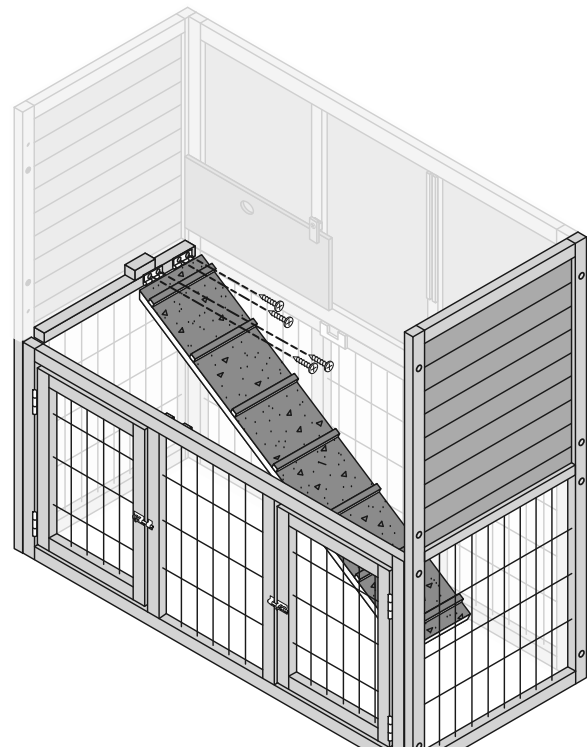

2 ...continued

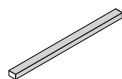

SUPPORT BAR

Insert the support bar into the holders. This will provide support for the floor tray.

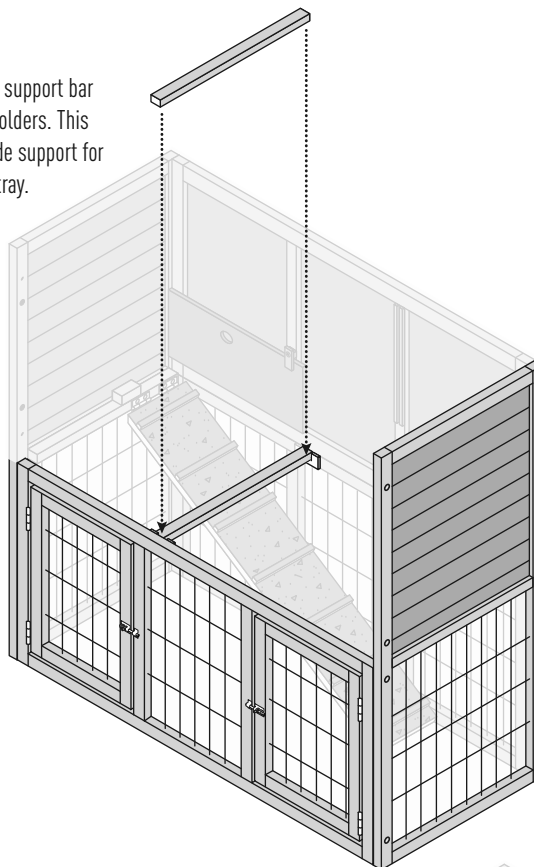

Cutaway view

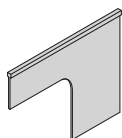

ROOM DIVIDER

Slide the room divider panel down into place.

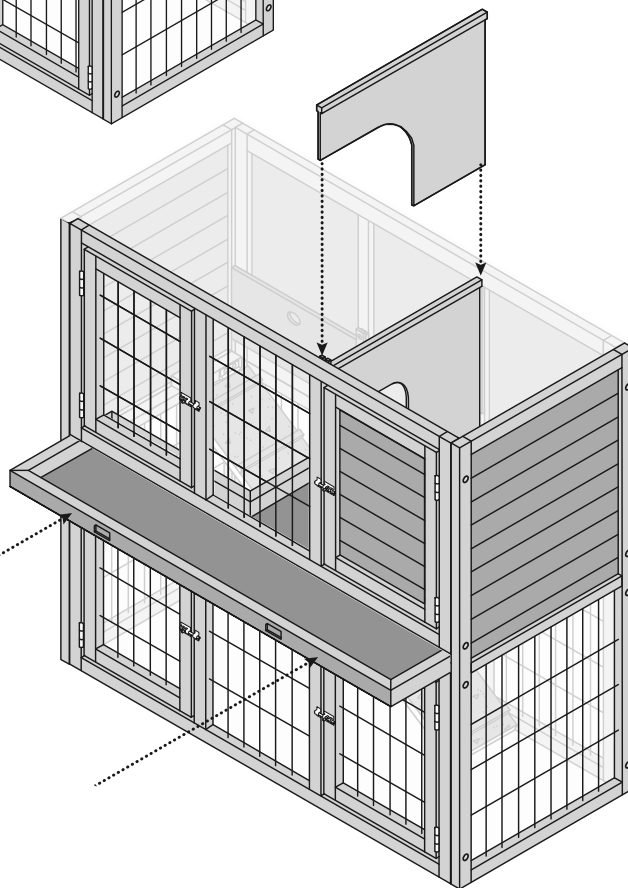

HUTCH FLOOR TRAY

Insert the floor tray.

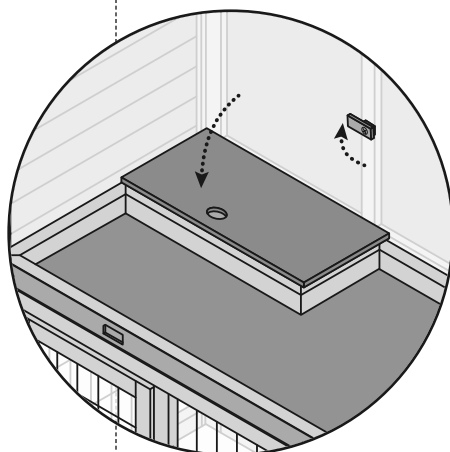
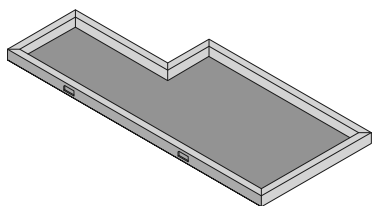

When the floor tray is in place, the trap door can be closed to separate the upper and lower levels.

3 Assemble the **ROOF**. You will need these pieces first:

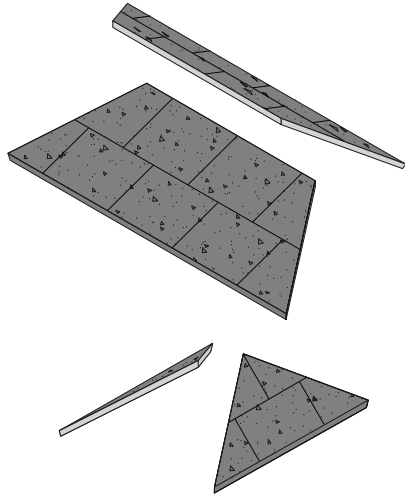

Center the front and back roof panels over the hutch. Catch the blocks (on the underside of the roof) onto the top of the hutch frame.

Tip the panels together and align them with your hands so they are flush at the peak and also side-to-side.

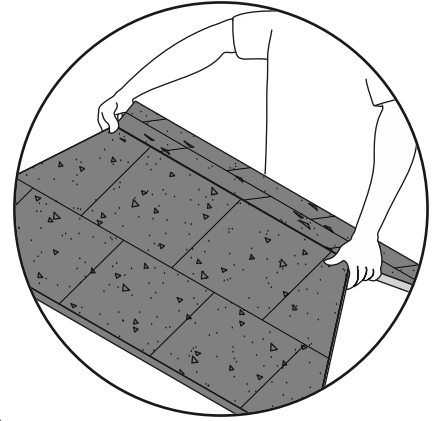
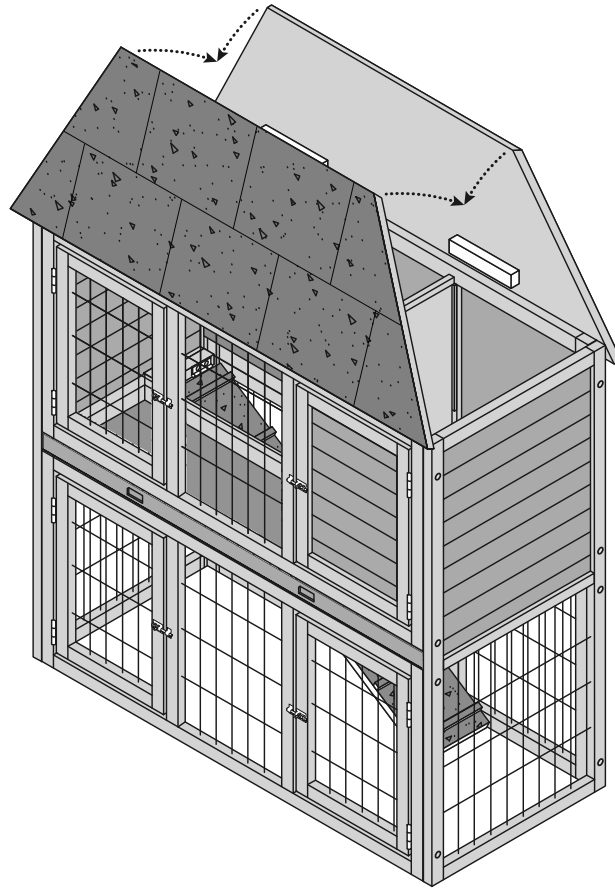

Tip the left side and right side roof panels into place.

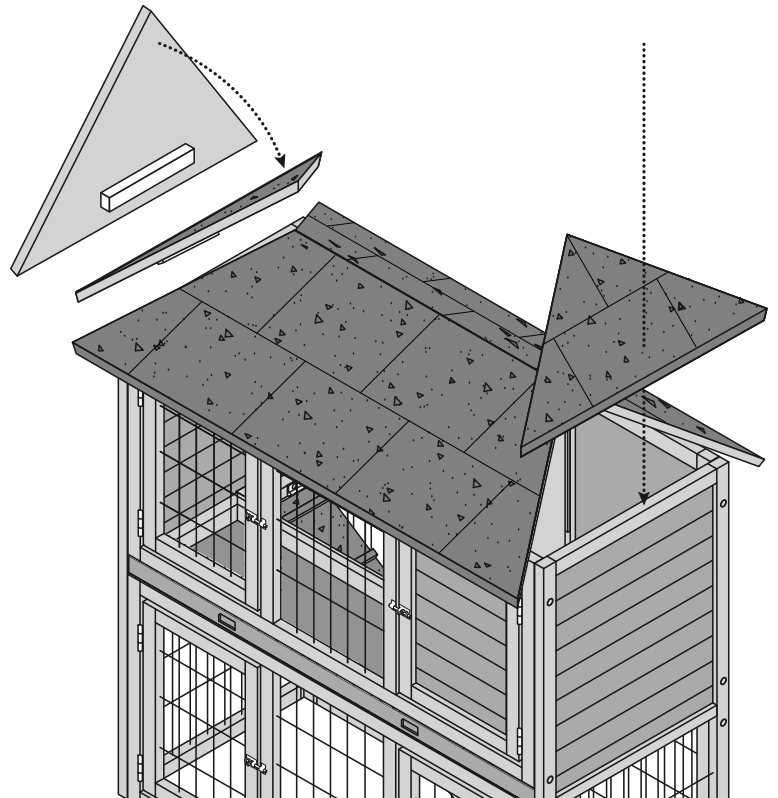

3

...continued

For the **ROOF TRIM**, you will need these pieces:

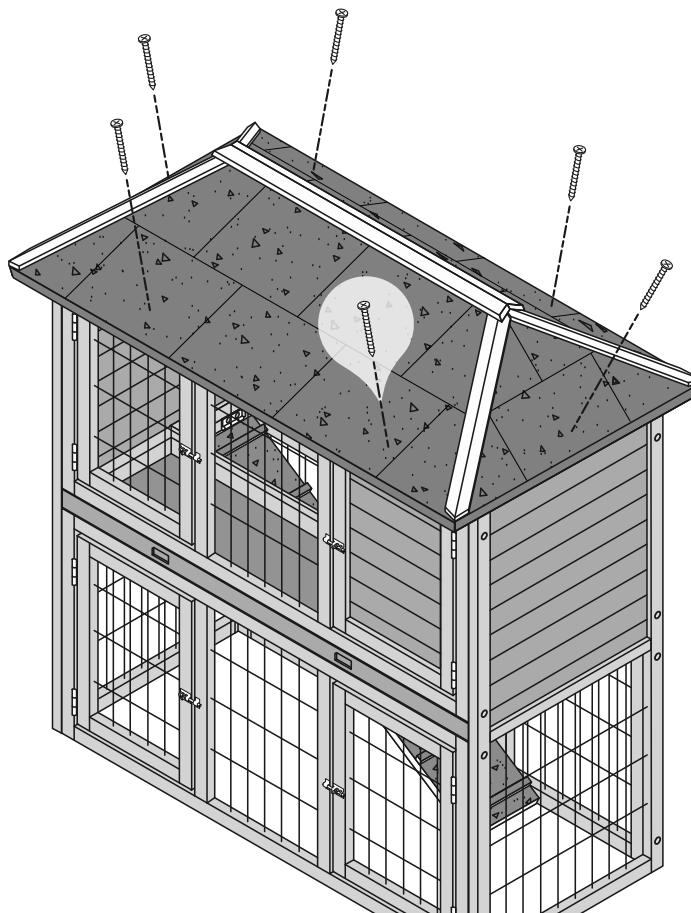
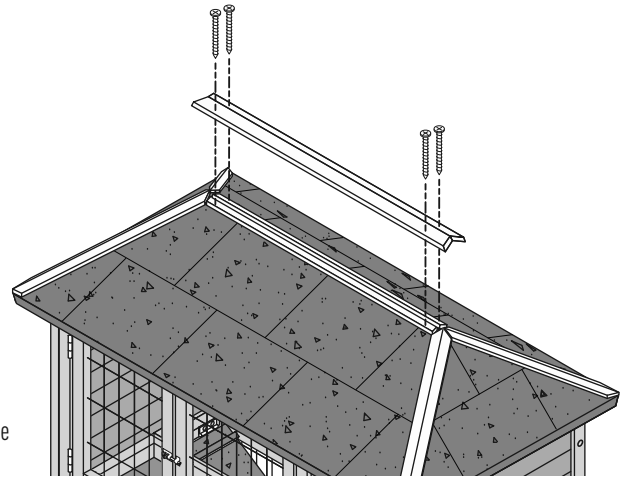
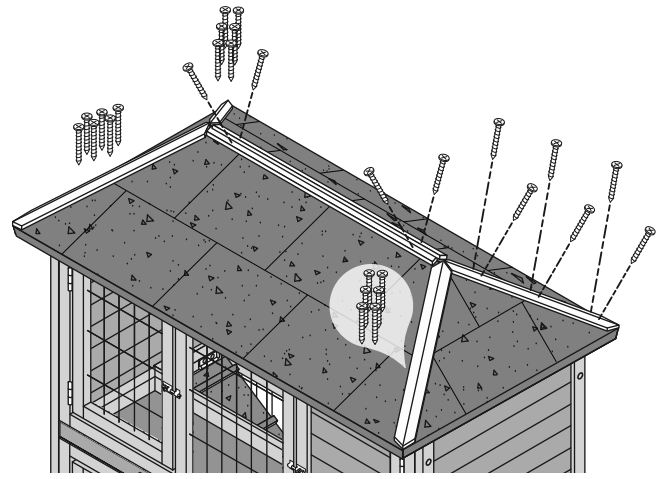
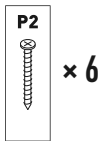
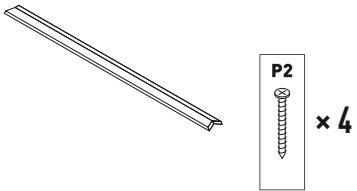
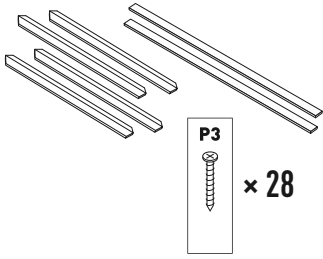

★
Your hutch is now fully assembled and ready for use.