

Travel Carrier

Model: # 1307

Instructions online at www.prevuepet.com

read first REVIEW BEFORE ASSEMBLY

- No tools are required for assembly
- For assistance or replacement parts, please contact Prevue Pet Products:

PHONE 312.243.3624

ONLINE www.prevuepet.com

EMAIL customerservice@prevuepet.com

1 To assemble the **CAGE BODY**, you will need these pieces:

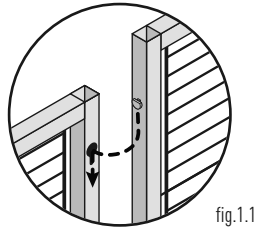
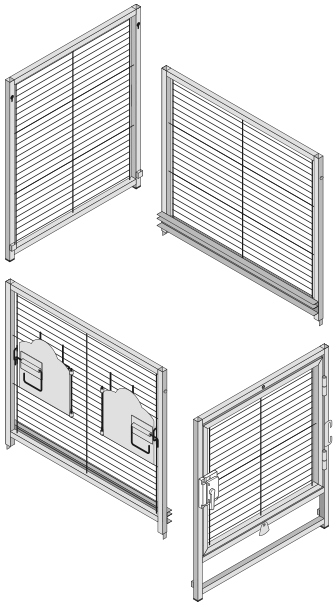

fig.1.1

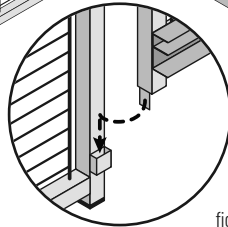
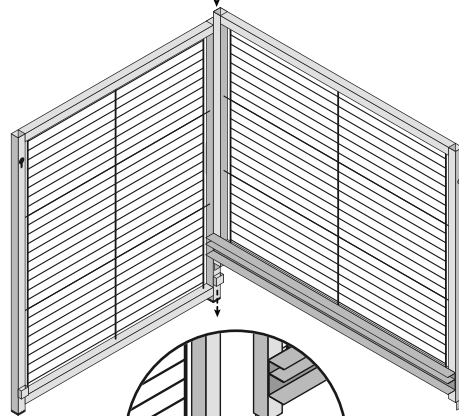
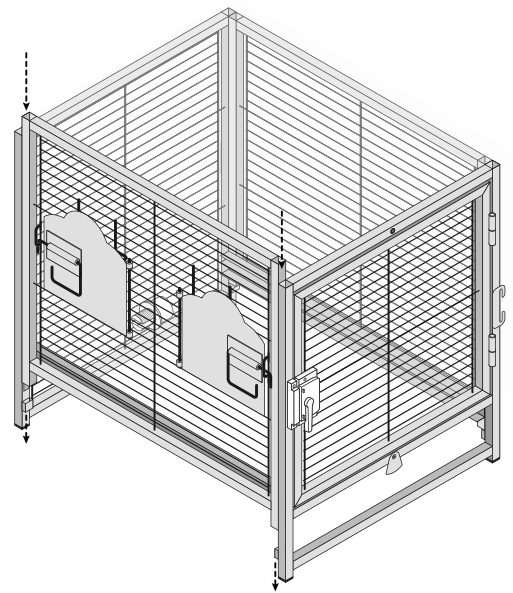

fig.1.2

Touch the vertical frame rail surfaces together, aligning the knob on the **side panel** with the hole on the **back panel** (fig.1.1) and the tab extension on the side panel over the sleeve on the back panel (fig.1.2). Slide the side panel down. The knob should lock into the hole and the tab should slide into the sleeve.

Add on the **side panel (with cup doors)** and the **front panel** following the same procedure.



2 To add the **ROOF** and **PERCH/HANDLE**, you will need these pieces:

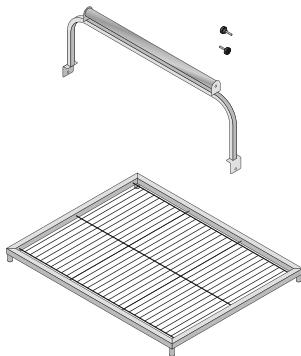

Set the **roof** into place. Posts at the corners of the roof will insert into the holes at the top corners of the front and back panels.

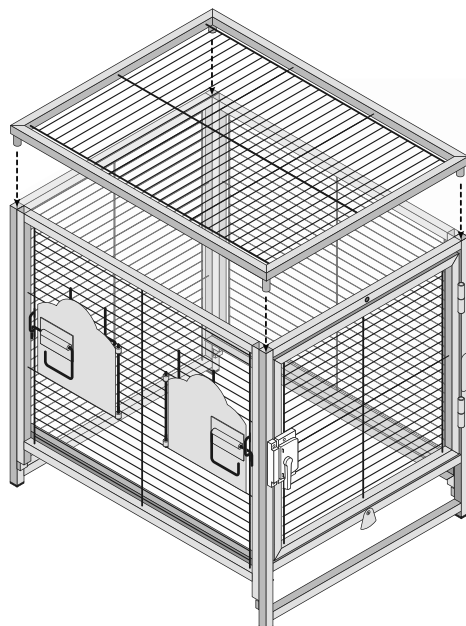

Set the **perch/handle unit** into place, aligning the holes of the bottom tabs with the holes on the front and back panels.

Screw the knobs into the aligned holes. This will secure the handle to the carrier and lock the roof in place.

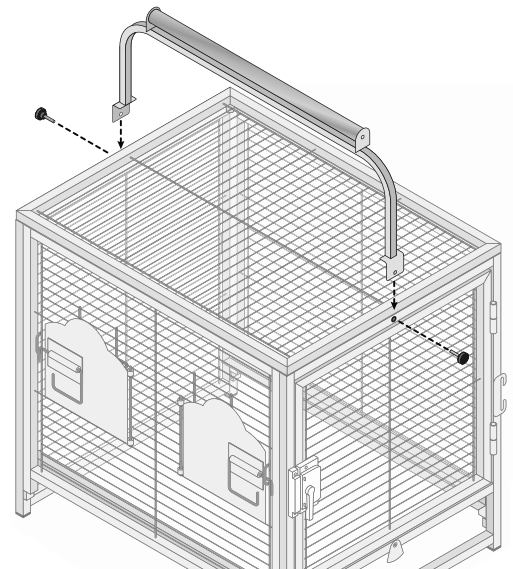

3 To add the **COMPONENTS**, you will need these pieces:

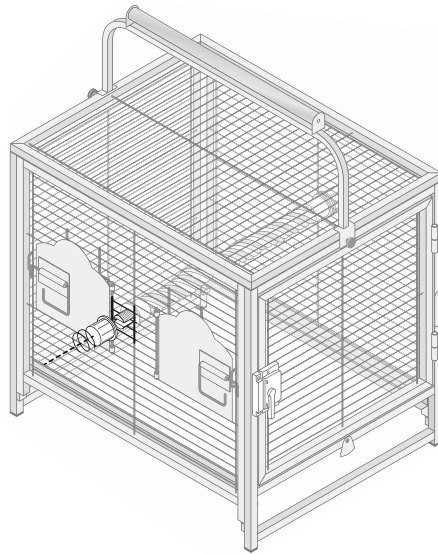
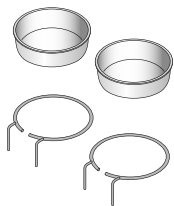
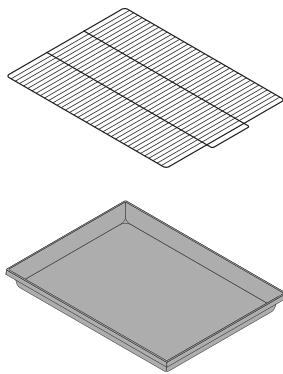
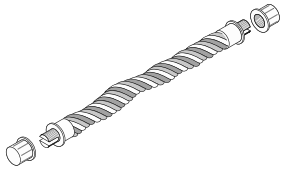

Unscrew the end-caps from the perch ends.
Place the perch inside the carrier and poke the notched screw-post through to the carrier exterior, catching a horizontal wire.
Screw the end-cap onto the screw-post from the exterior (fig.3.1). Tighten to a stable, snug fit.
Follow the same procedure for the opposite end.

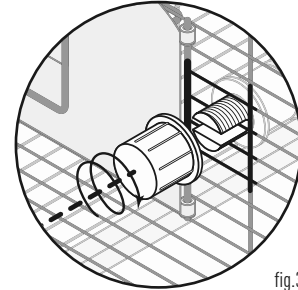
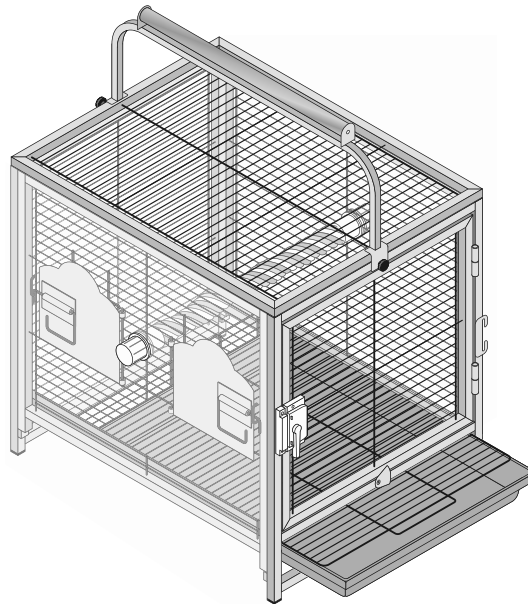
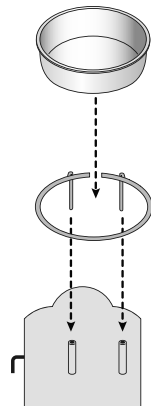

fig.3.1



Rotate the windbell lock out of the way and slide the grille into the top track and the tray into the bottom track.



Open the cup door, and insert the cup into the cup holder, and insert the posts of the cup holder into the sleeves on the inside of the door (fig.3.2).

fig.3.2

