



MODEL #
98005

MODEL #
2003

Hamster Haven /small ASSEMBLY

Instructions online at www.prevuepet.com

CUSTOMER SUPPORT

For assistance or replacement parts,
please contact Prevue Pet Products:

PHONE 1 (312) 243-3624

ONLINE www.prevuepet.com

EMAIL customerservice@prevuepet.com

1 PIECES

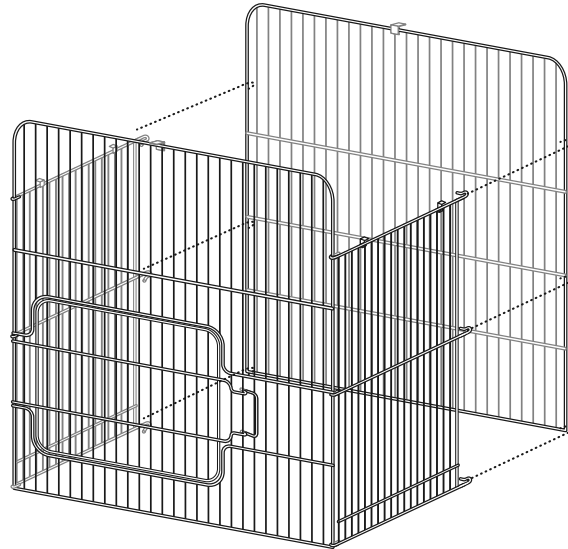
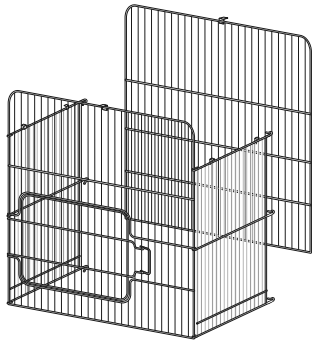

Starting from the bottom, pull the extended hooked wires of the side panel onto the back panel. The middle wire hooks under the corresponding horizontal wire on the back panel.

Link one complete seam together, then finish with the remaining seam.

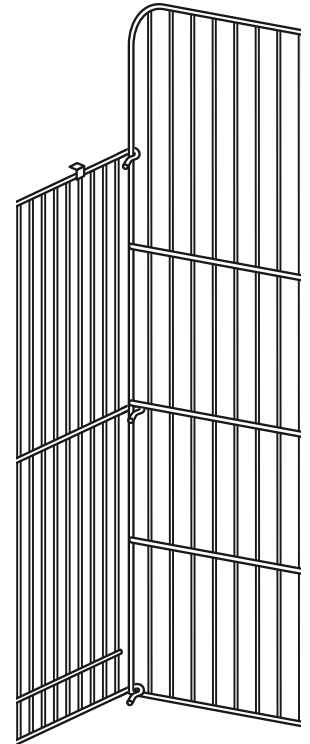

DETAIL OF INSIDE BACK, LEFT CORNER

2 PIECES

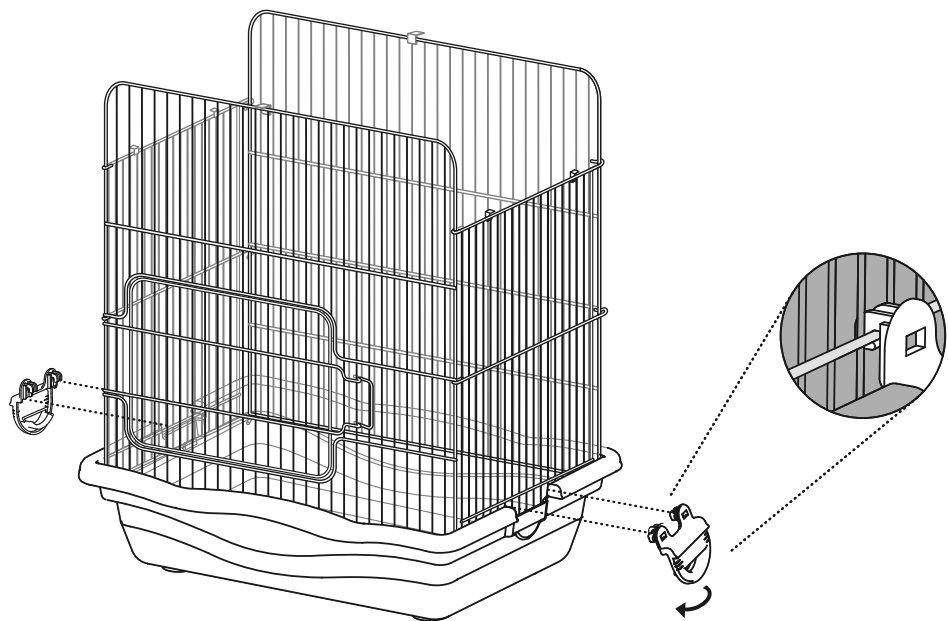
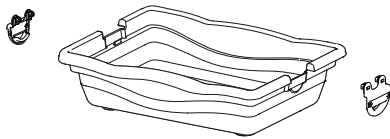

Set the assembled mesh into the base and attach with the clips. Hook the base clips onto the horizontal wire and clip it onto the base by pushing down until it "clicks".

3 PIECES



SNAP THE TRANSLUCENT WHEEL COVER ONTO THE BACK

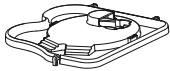
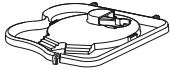

Position the wheel close to the base floor. Insert the handle on the back of the wheel through the cage wires.

Rotate the handle 90° to secure the wheel.

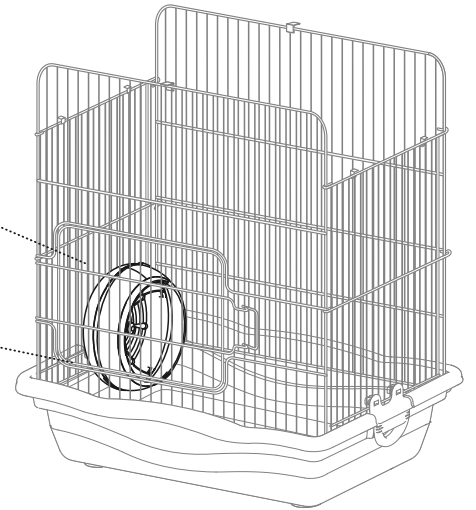
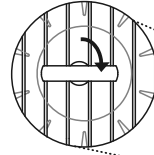

First, install the lower platform (without the hideaway dome). Add a slide into the hole on the platform.

To the upper platform, add the slide, then center the hideaway dome over the raised circle and rotate it into place with a "click".

Install the second platform into the cage.

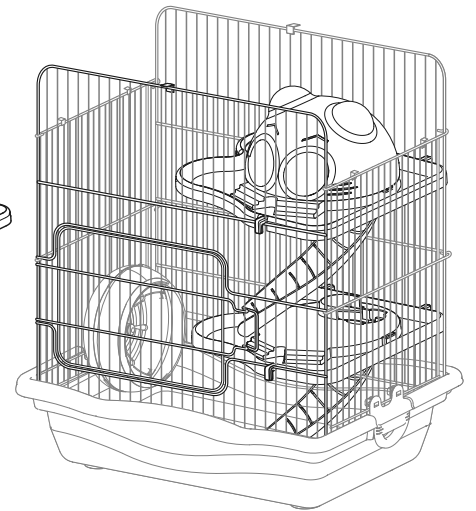
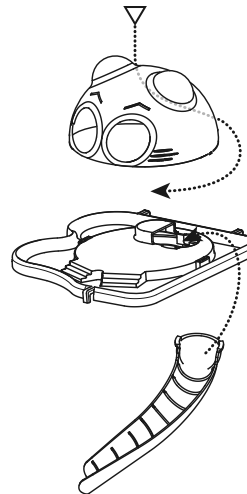

4 PIECES

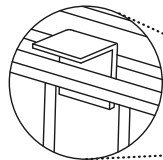
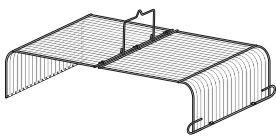

Catch the center of the rooftop on the tabs at the front and back.

Finish with catching the roof ends on the tabs along the side panels.

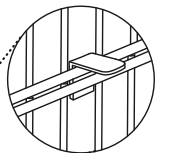
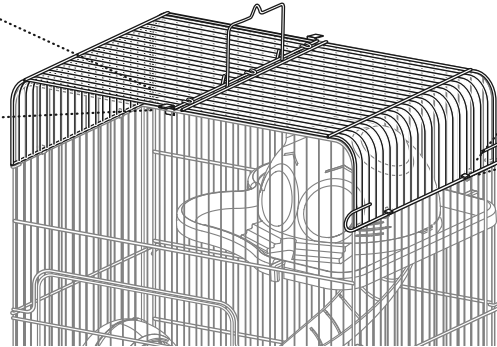

The end with the extended handle loops is hinged along the center seam, and offers rooftop cage access.



CLEANING INSTRUCTIONS

To prolong the life of your new Prevue Pet Products cage, we recommend:

- When cleaning the cage and parts, use a soft cloth or non-abrasive scrub pad (such as Prevue's Cage Saver (#109)).
- Wash all parts with warm water and a mild environmentally friendly, pet-safe soap.
- Rinse thoroughly.
- Hand dry all parts completely with a soft dry cotton cloth before reassembling the cage.
- Do not leave plastic parts in the sun to dry as they may warp.

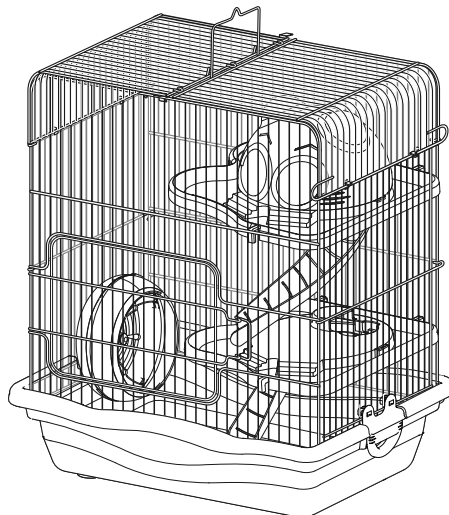

Assembly completed.