



MODEL #
222BLK

MODEL #
222W

Crystal Palace PARTS LIST

Instructions online at www.prevuepet.com

CUSTOMER SUPPORT

Please contact Prevue Pet Products:

PHONE 1 (312) 243-3624

ONLINE www.prevuepet.com

EMAIL customerservice@prevuepet.com

KEY:

R = Roof

WP = Wire Panel

GP = Glass Panel

G = Grille

T = Tray

B = Base

*
These pieces are interchangeable:
WP 1 = WP 2
GP 1 = GP 2

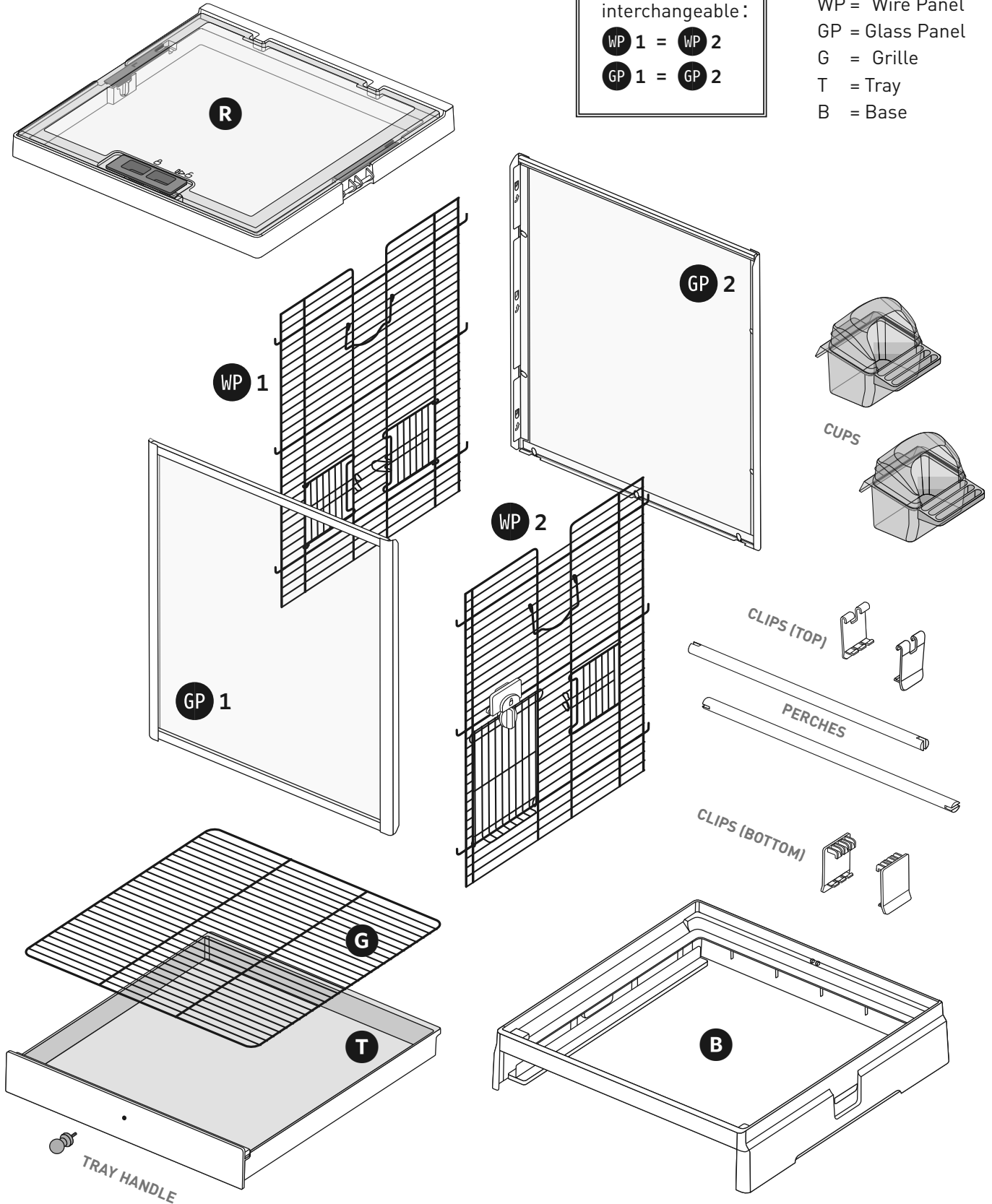

For best results, follow the Assembly Steps in the order presented.

1

PIECES

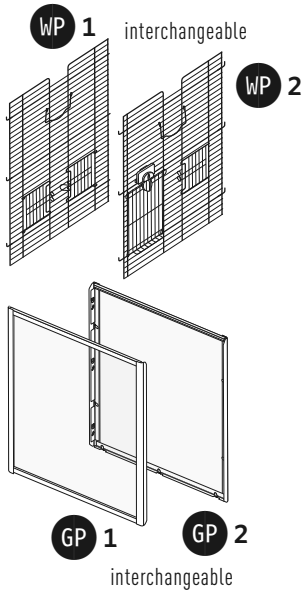

Check that the arrows on the glass panels are pointing UP.

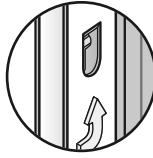

Insert all three "L"-shape hooks on the wire panel into the space between the metal framing, under the arrows.

Tap the glass panel down onto the hooks to catch the hooks on the tabs between the framing.

Continue around the cage, hooking glass panel to wire panel to glass panel.

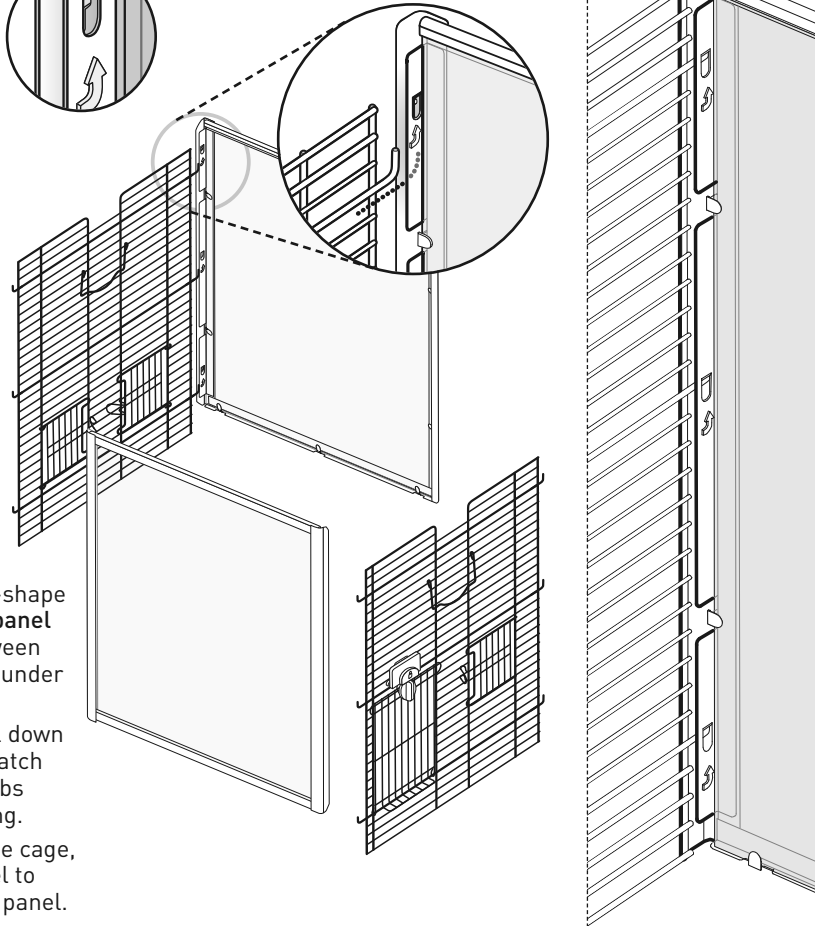

2

PIECES

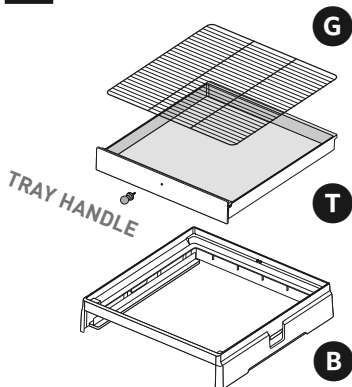

1 Screw the tray handle into the tray.

2 FIRST, add the grille on the top racks. SECOND, add the tray. The tray locks the grille in place.

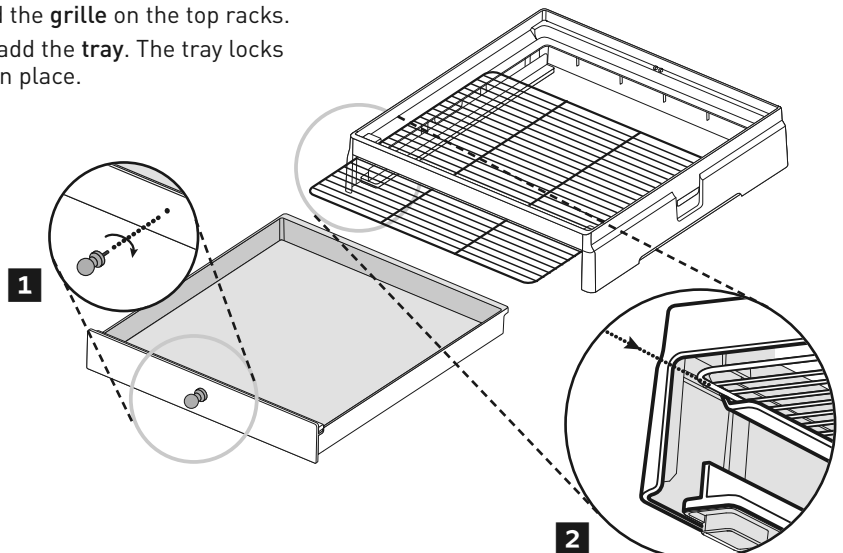

a view from the underside of the base

3 PIECES

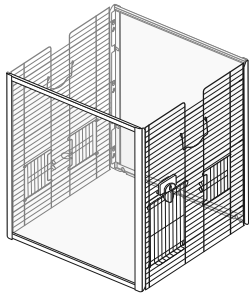

assembled unit from STEP 1

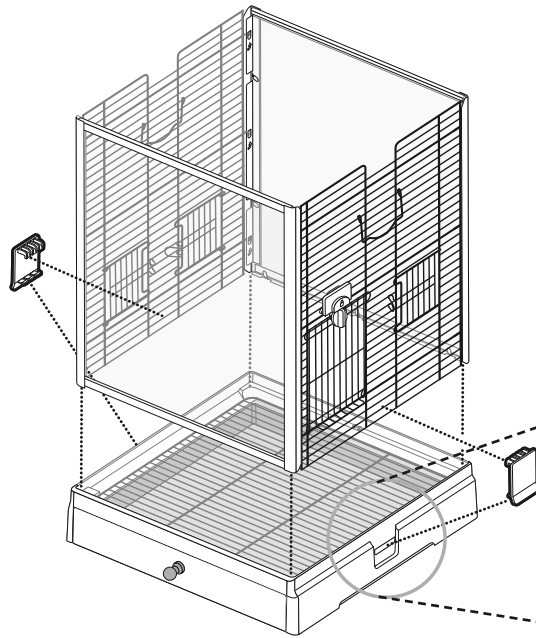
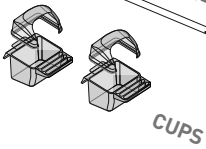
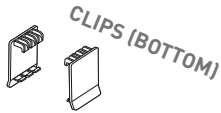

Add the assembled cage body onto the **base** (the tray and glass panel face the front).
Attach the wire panels to the base: catch the claws of the **bottom clips** onto the wire, and clip the lower half into the slot on the base.

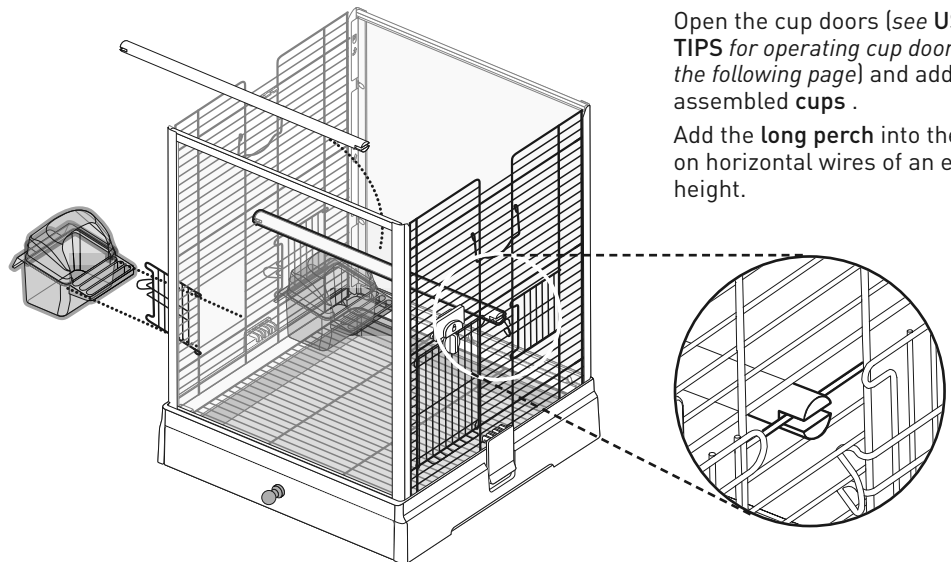

Open the cup doors (see **USAGE TIPS** for operating cup doors on the following page) and add the assembled **cups**.
Add the **long perch** into the cage on horizontal wires of an equal height.

4 PIECES

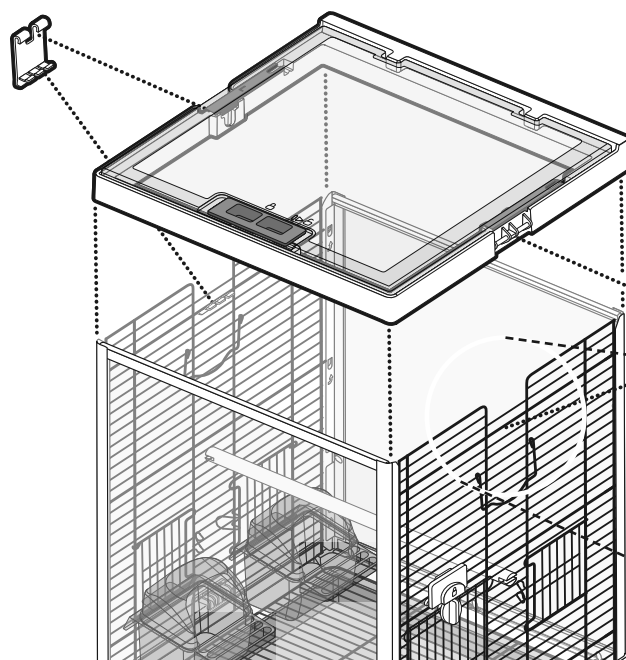
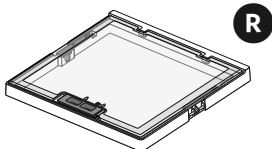
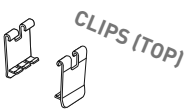

Place the **roof** on the top of the cage body, with the lid lock at the front.
Clip the roof to the wire panels: catch the claws at the top of the clip on the roof, and clip the bottom into the wire on the side panels.

5 PIECES

PERCH (SHORT)

Slide the roof lock to the RIGHT to unlock. (Slide back to the LEFT to lock.)

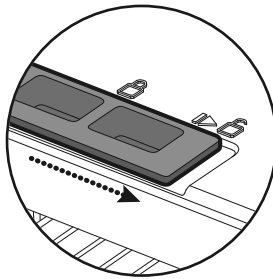

Open the roof and prop the lid up with the integrated legs on the left and right sides.

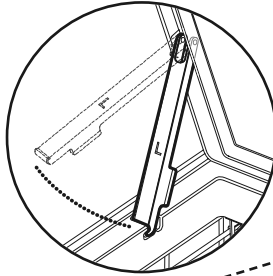

Add the short perch into the slots on the inner track of the roof.

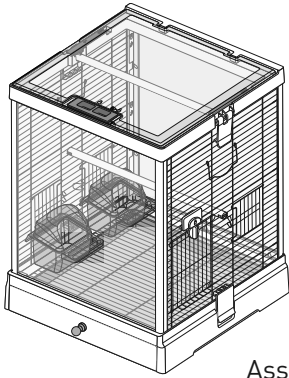
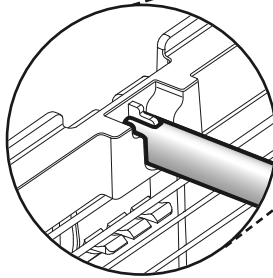

Assembly completed. ■

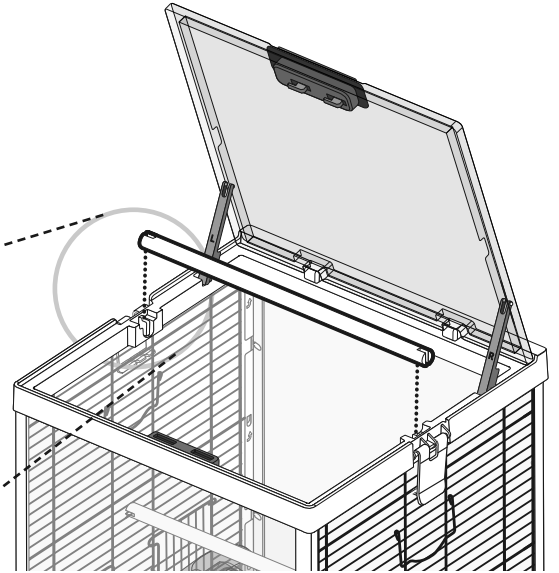

Crystal Palace USAGE TIPS

TOY RING

A ring has been included for adding toys to the roof perch. Open the ring and add the toy or toy quick link, and then snap it around the perch. Or, slide the ring onto the perch before installing, and add a toy/quick link to the ring already on the perch.

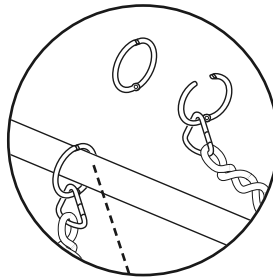

CUP DOORS

TO OPEN:
Pull sideways and out.

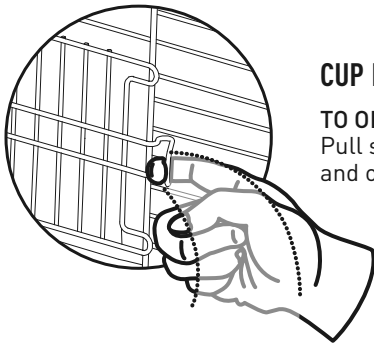

TO CLOSE:
Push in with your thumb at the area indicated.

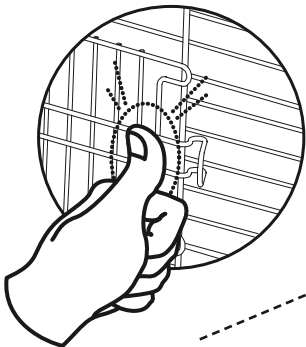

ACCESS DOOR

TO OPEN:
Turn the knob to the right or left to release the lock.

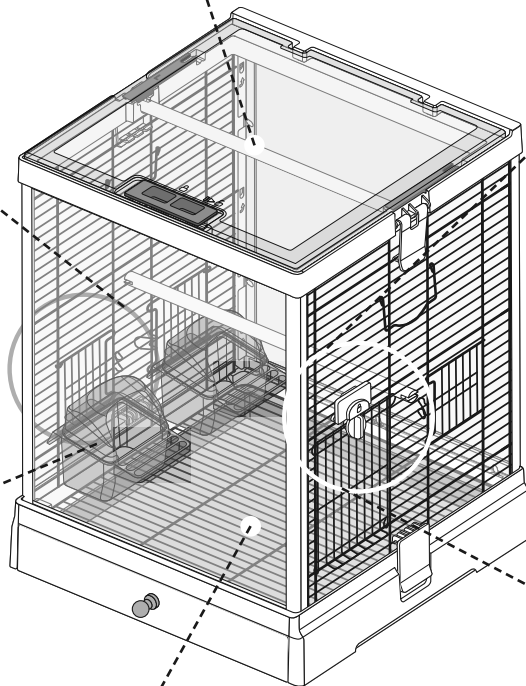
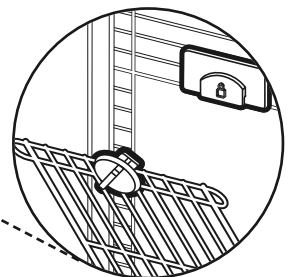
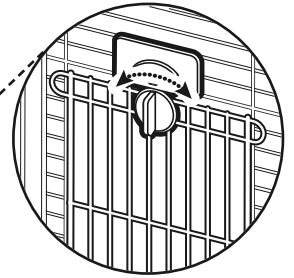

CAUTION: GLASS PANELS

Always take caution around the clear glass front and back panels. Clean with water and odorless, pet-safe soap or cleaner.