



Universal Small Animal  
Home/ Ranch  
**PARTS LIST**

Instructions online at [www.prevuepet.com](http://www.prevuepet.com)

**CUSTOMER SUPPORT**

Please contact Prevue Pet Products:

**PHONE** 1 (312) 243-3624

**ONLINE** [www.prevuepet.com](http://www.prevuepet.com)

**EMAIL** [customerservice@prevuepet.com](mailto:customerservice@prevuepet.com)

**KEY:**

- R = Roof
- LP = LEFT Panel
- BP = BACK Panel
- FP = FRONT Panel
- RP = RIGHT Panel
- B = Base

**HARDWARE:**



**Corner Connectors**  
4 pieces



**Base Clips**  
8 pieces



**Cage Connectors**  
22 pieces

- 12 for cage assembly
- 8 for roof (optional)
- two extras

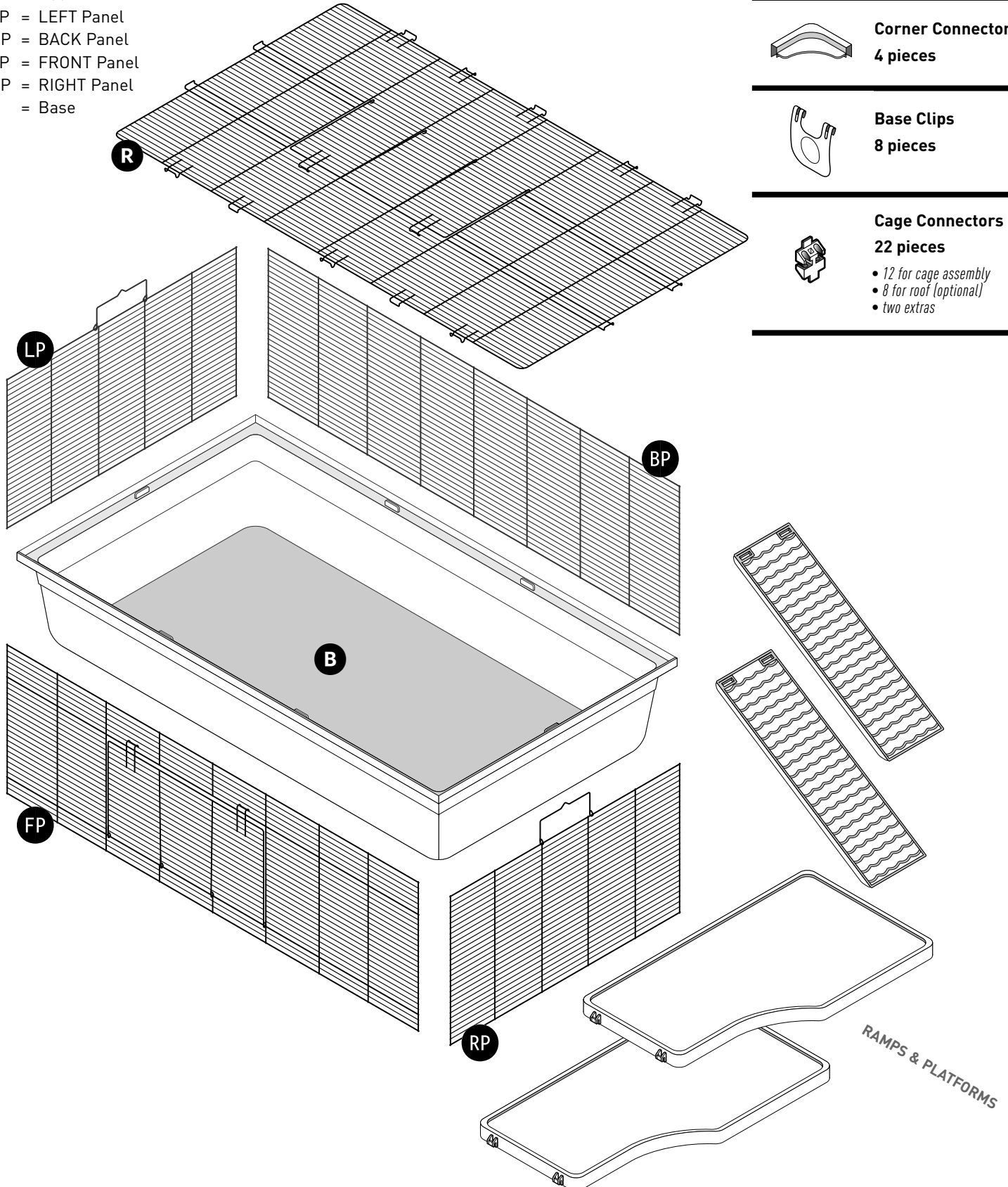

**1** PIECES

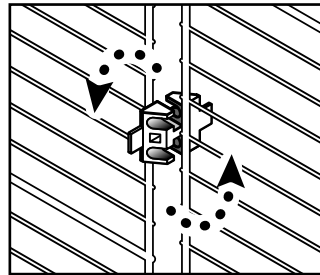
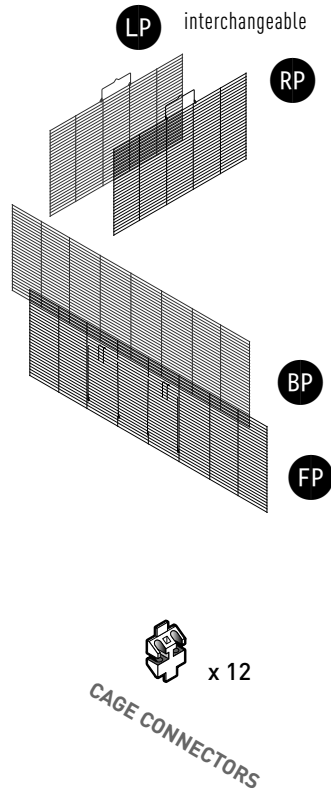

• Insert the **connector** between the panels and twist 90°.

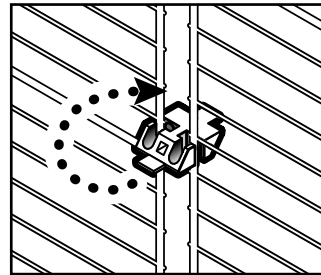

• Flip the connector up and click it onto the vertical wires, above and below the horizontal wire.

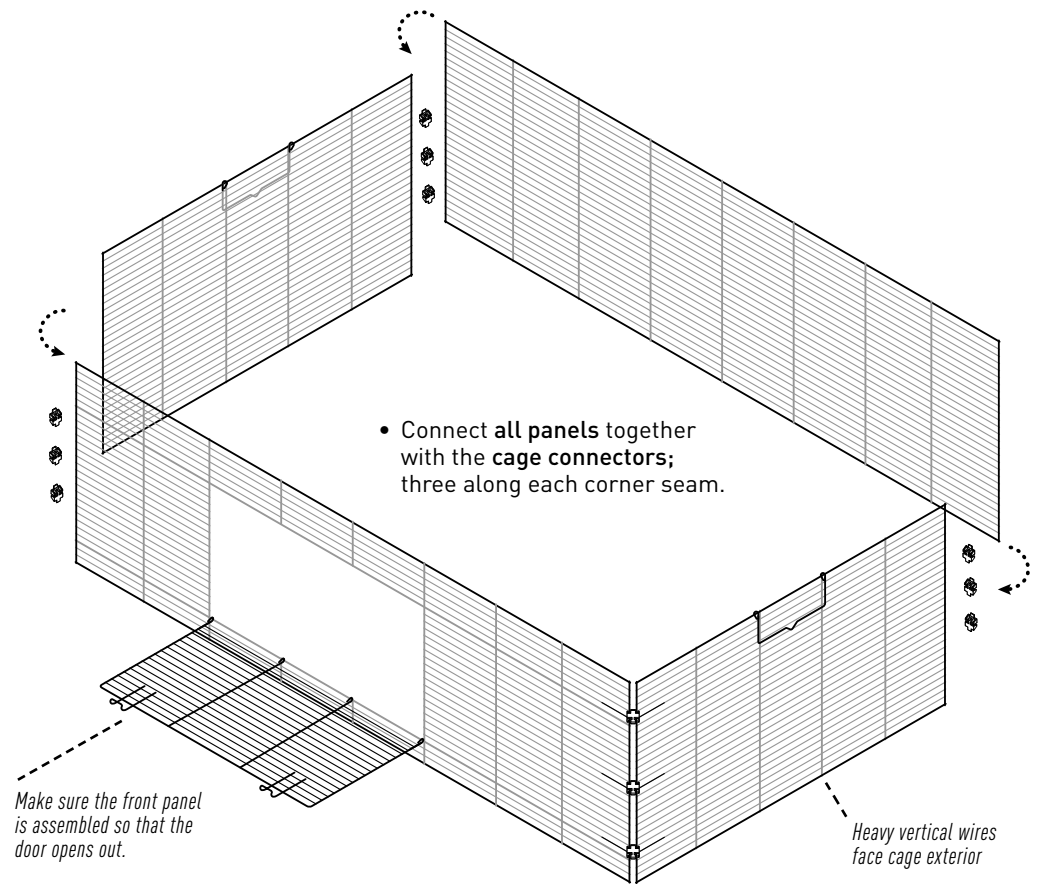
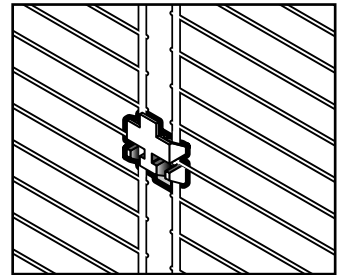

**2** PIECES

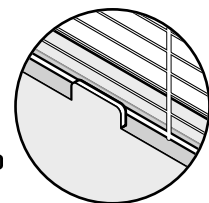
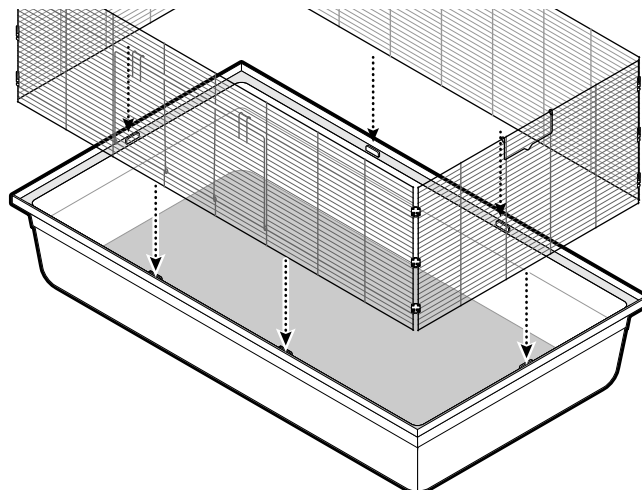
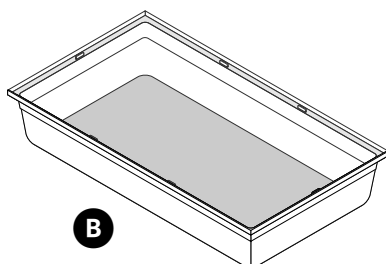

• Set the assembled cage body into the **base**, making sure all bottom wires are positioned between the outer rim and inner raised tabs.

# 3 PIECES

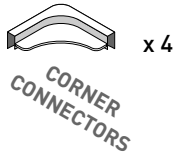

- Push the **corner connectors** down over the corner seams.

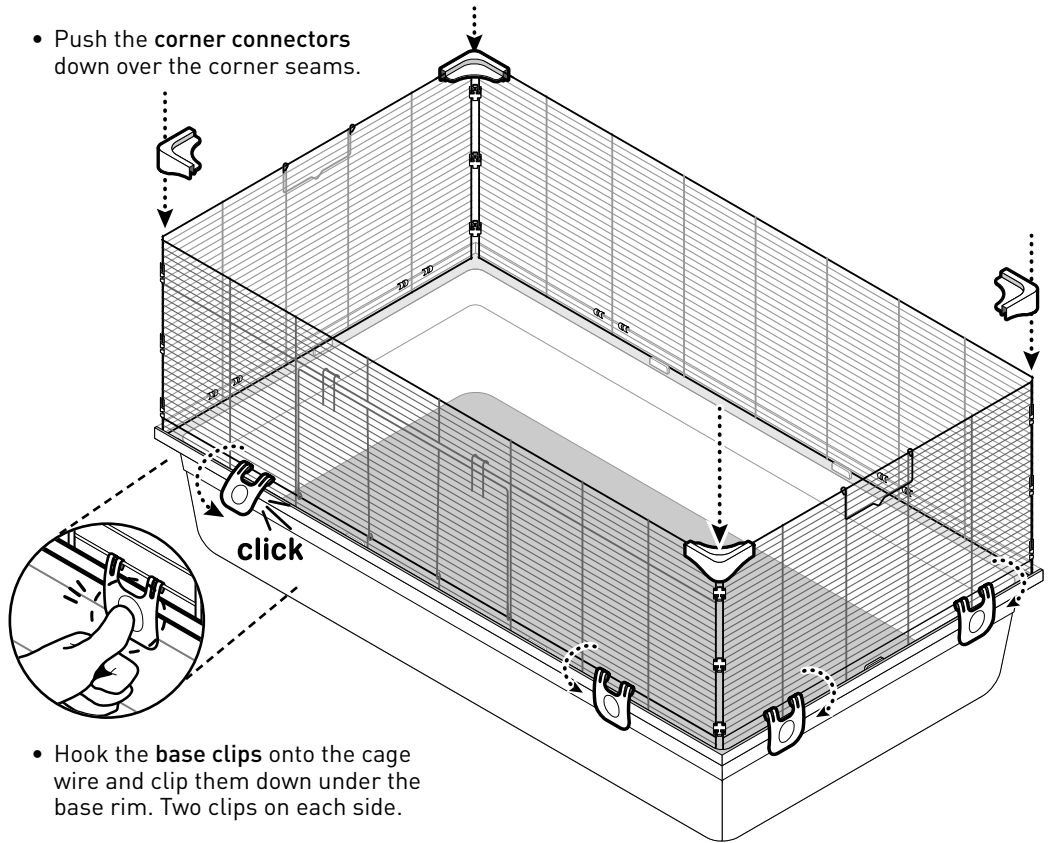

- Hook the **base clips** onto the cage wire and clip them down under the base rim. Two clips on each side.

# 4 PIECES

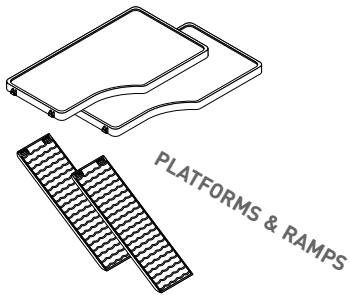

- Hook the **ramps** onto the underside of the **platforms** first.

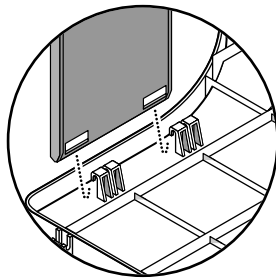

- Insert the **platforms** into the cage (lower platform/ramp first). Set the extended tabs over horizontal wires at an equal height along the front and back. Push tabs down onto the wire to lock the platforms in place.

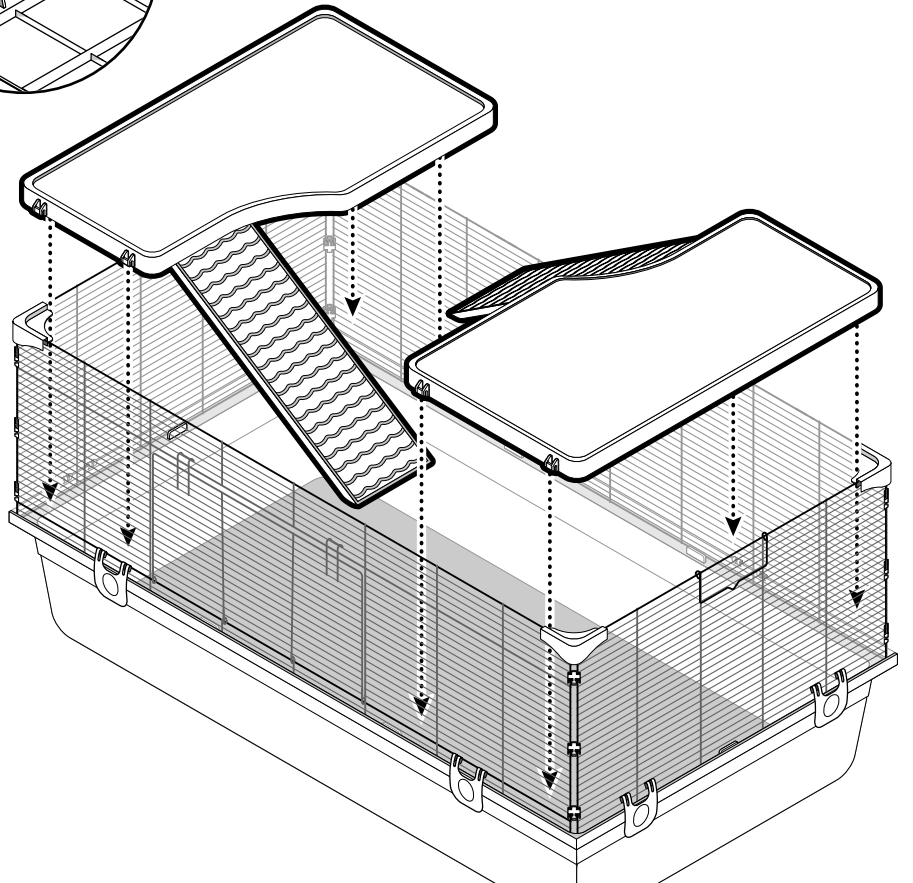

# 5 PIECES

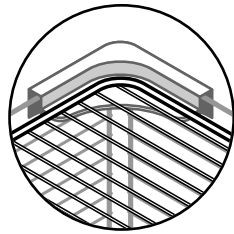
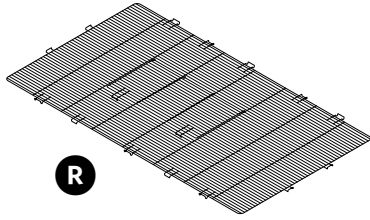

- Set the roof on the corners, and arrange the extended wires as detailed below:

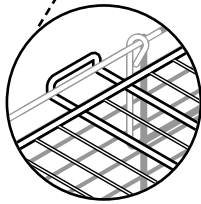
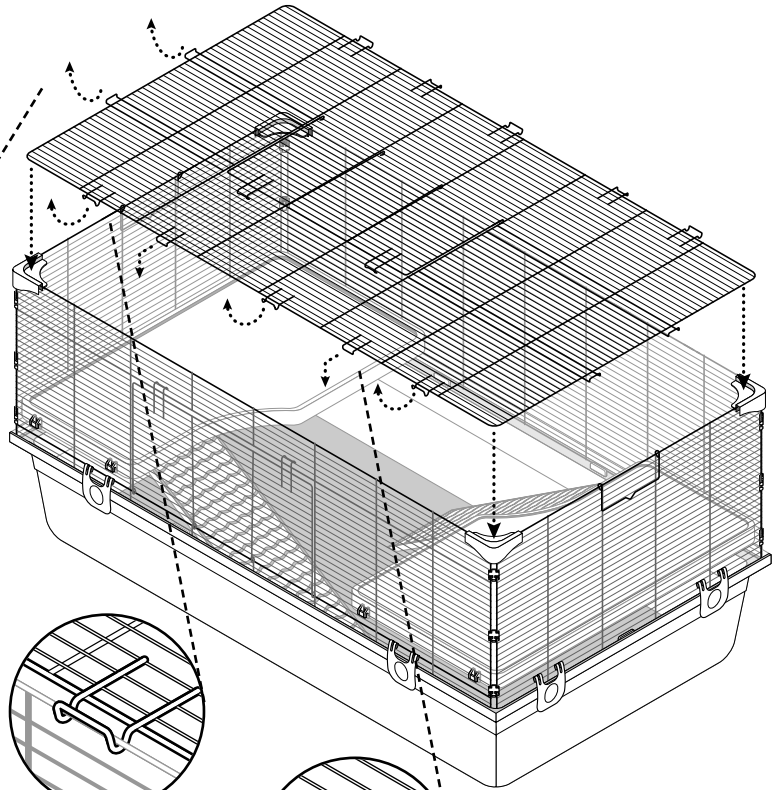

- UNDER the cage body

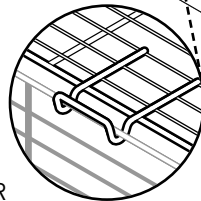

- UNDER the cage body

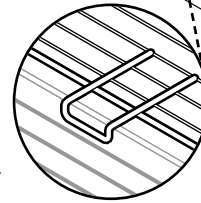

- OVER the cage body

# \* OPTIONAL

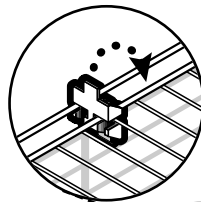
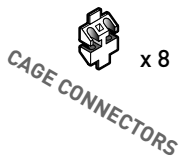

- For additional roof closure security, add cage connectors along the front, back, and sides.

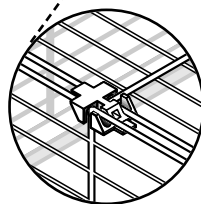

*For best results along the front and back, align the cage connectors with the heavier cross-wire, as illustrated.*

Assembly completed. 