

Small Round Bird Cage
PARTS LIST

Instructions online at www.prevuepet.com

CUSTOMER SUPPORT

Please contact Prevue Pet Products:

PHONE 1 (312) 243-3624

ONLINE www.prevuepet.com

EMAIL customerservice@prevuepet.com

KEY:

R = Roof

CB = Cage Body

G = Grille

B = Base

TL = Tray (left)

TR = Tray (right)

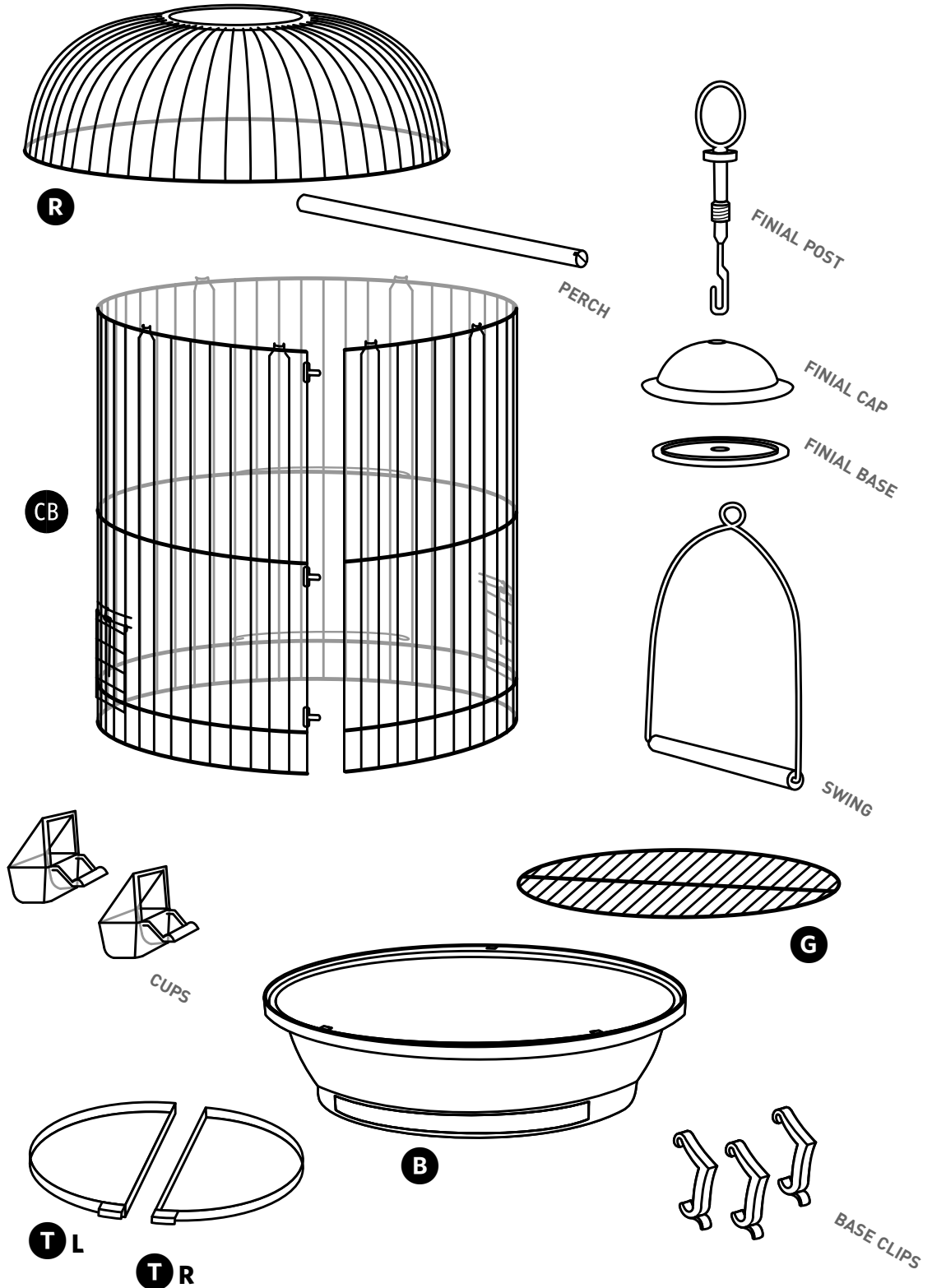

1 PIECES

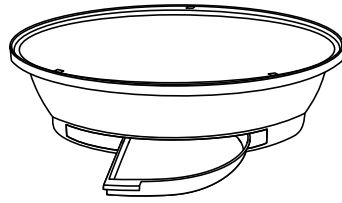
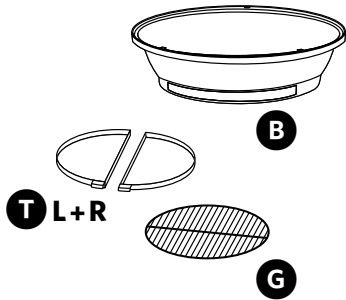

Slide one half-tray into the opening in the base and tuck it to one side to make room for the other tray half.

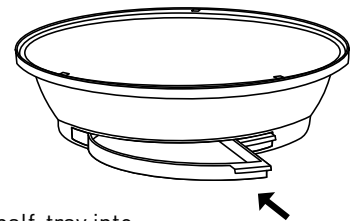
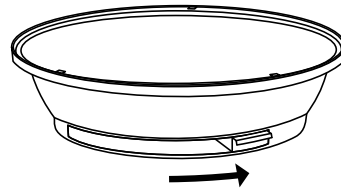

Slide the other half-tray into the opening, and then add the grille into base from the top.

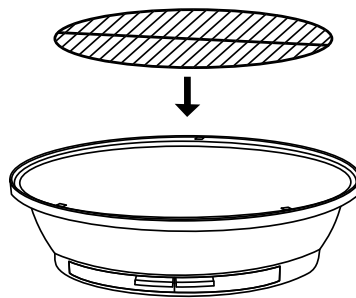

2 PIECES

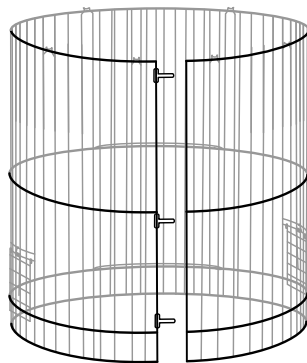
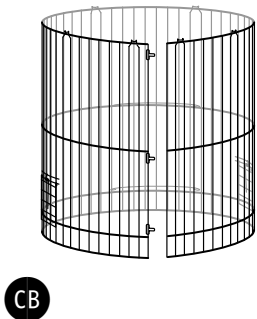

Pull the **cage body** seam together and fold the thin metal tabs around both wires to secure the seam.

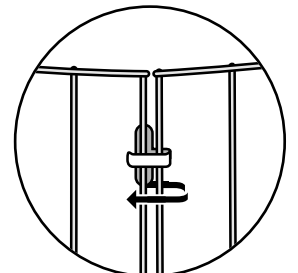
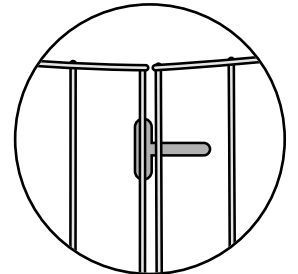
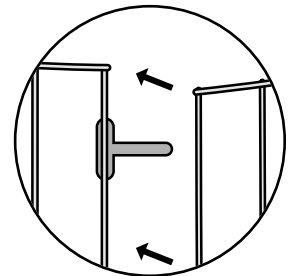
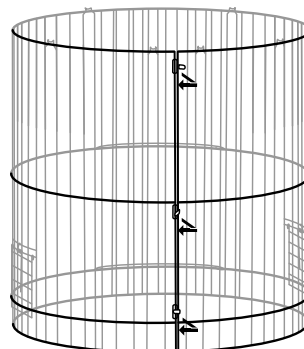

3 PIECES

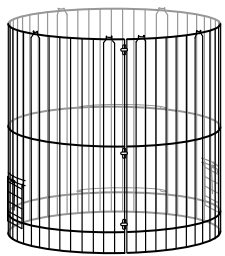
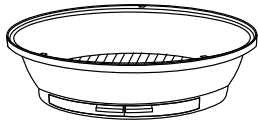
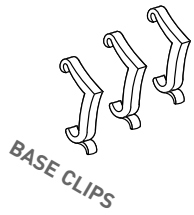

1 Place the **cage body** onto the **base** and catch the bottom wire under the tabs along the base rim.

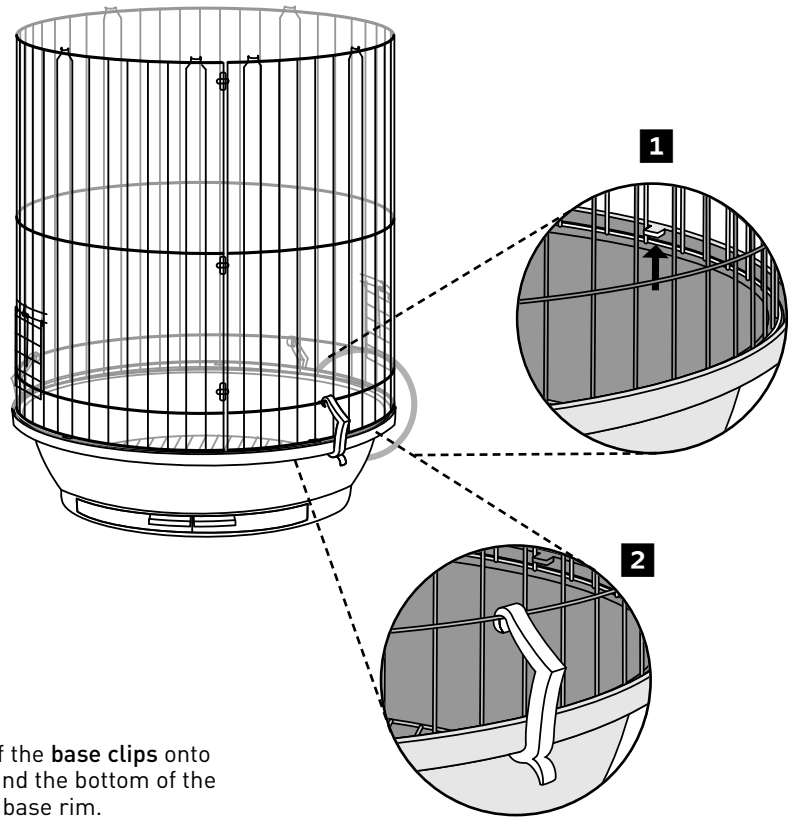

2 Catch the top of the **base clips** onto the cage body and the bottom of the clips under the base rim.

4 PIECES

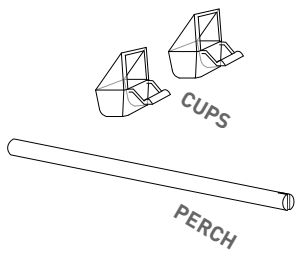

Assemble the two-piece cups.

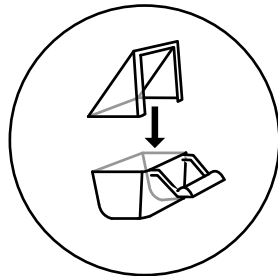

Hold the hinged cup doors up and insert cups into place. Be cautious when opening/closing the snap-hinge doors — watch your fingers and don't allow the doors to snap down onto the cups.

Install the perch down in the cage, away from the swing.

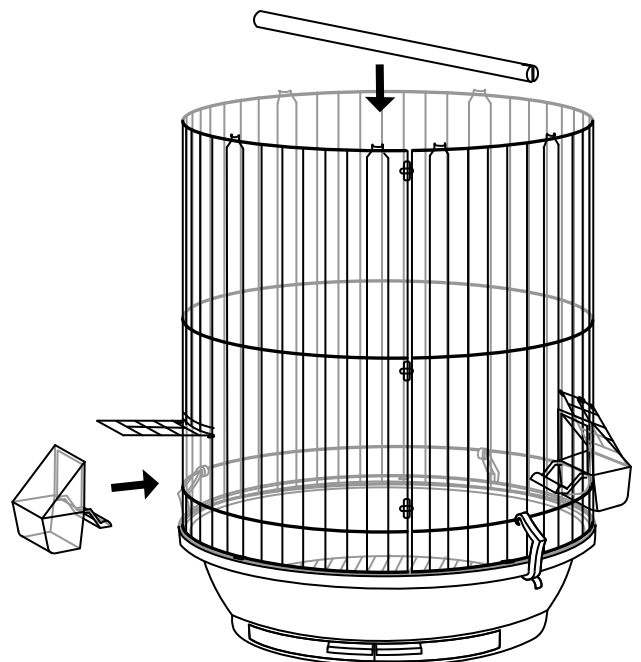

5 PIECES

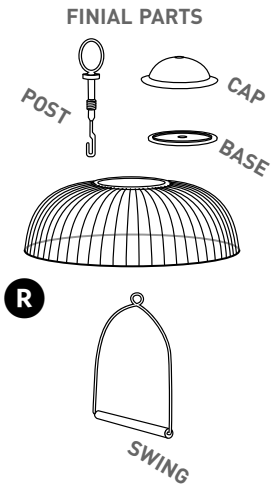

- 1 Insert the finial post through the finial cap...
- 2 ...and down onto the roof.
- 3 From the underside, insert the finial base (with raised rim facing up) onto the finial post end.

Screw the post into the threaded screw hole of the base until snug — do not overtighten.

- 4 Connect the swing onto the hook-end of the post.

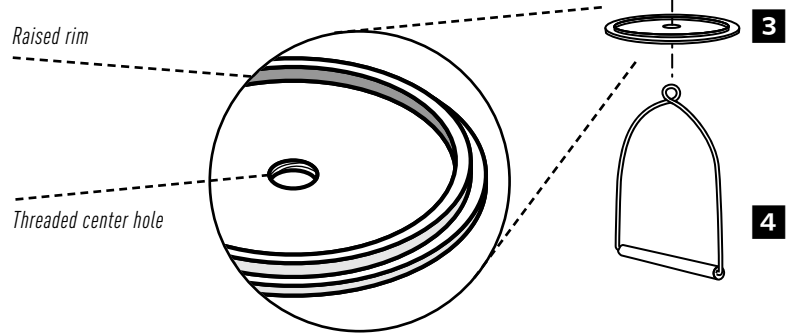

Place the assembled roof onto the cage body, and catch the roof under the tabs all around the rim.

